

TVI



INSTRUCTION MANUAL

ELECTRIC WINCH TVI SERIE



To ensure the constant improvement of its products, VERLINDE reserves the right to change the equipment as described below and, in this case, to supply products which differ from the illustrations in this instruction manual.

All rights reserved

Summary

1 - Contents.....	2
2 - What not to do.....	3
3 - Compulsory regulatory inspections by the user.....	3
4 - Introduction to the machines.....	4
5 - Handling - Storage.....	7
6 - Installation and start-up.....	7
7 - Servicing and maintenance.....	14
8 - Decommissioning.....	15
9 - Spare parts.....	15
10 - Troubleshooting.....	16
11 - Declaration of conformity.....	17
12 - Appendixes.....	18

1 – Contents

All users are asked to read the start-up instructions carefully before using the winch for the first time. These instructions will help the user to become familiar with the winch and to use it to the best of its capabilities. The start-up instructions contain important information on how to use the winch in a safe and correct manner. Observing these instructions can help prevent risks, minimize repair costs, reduce down time and increase the reliability and useful life of the winch. The instruction manual must always be available at the winch operation location. In addition to the start-up instructions and the regulations relating to accident prevention, it is important to consider current rules in terms of TVII safety and professional standards in force in each country.

This machine is covered by European regulations and, more specifically, machinery directive 2006/42/CE, EMC directive 2004/108/EC and low-voltage directive 2006/95/EC, as well as standard EN 14492/1.

The TVI Series winches can be used to perform lifting and pulling operations.

- When used for lifting, European regulations require the use of certain equipment, including a limit stop and a load limiter (above 1000 kg).
- The user must make sure that this equipment is in place (optionally available from the manufacturer) before undertaking any lifting operation.
- Please ensure that the operator is qualified to operate the winch under the conditions laid down in this manual. This is to respect the safety of workers and the environment.
- The capacity indicated on the winch corresponds to the maximum operational capacity (M.O.C.), which may not be exceeded in any case.
- This winch may not be used to lift personnel under any circumstances.
- Do not lift or carry loads while personnel remains in the danger zone.
- Do not authorize personnel to walk under a hanging load.
- Never leave a load hanging or under tension without supervision.
- Never begin to handle a load without fixing it correctly and making sure that all personnel has left the danger zone.
- Before each use, the operator must check that the machine, its ropes, its hook, its markings and its restraints are in good condition.

- The operator must make sure the load is hooked so that the winch, the rope and the load do not pose any risk for him or other personnel.
- The winches can be handled within a range of ambient temperatures between -10° C and +50° C. Please consult the manufacturer in the case of extreme operating conditions.
Warning: When the ambient temperature is less than 0°C, the brake must be tested in order to make sure it has no operating faults caused by frost.
All uses of the winches must strictly conform to accident prevention and safety measures for the country where they are being used.
- The manufacturer accepts no responsibility for the consequences of the machines being used or installed in ways other than described in the manual, or for the consequences of altering or replacing original parts or components with parts or components from other sources without its written agreement.

YOU ARE ALSO REQUIRED TO OBSERVE THE APPLICABLE RECOMMENDATIONS IN YOUR COUNTRY.

2 - What not to do

Before using the winch, make sure there is no risk of overloading due to adherence to the floor, suction, jamming, etc. of the load. In addition to the above, avoid all the incorrect uses and operations indicated below. It is dangerous and prohibited to:

- unwind the drum completely (always leave 2 to 3 coils).
- pull at an angle.
- swing the load.
- use ropes with a diameter and texture that do not comply with the specifications of this manual (FEM 1 Am – ISO M4)
- use damaged or spliced ropes.
- use hooks without catches, not suitable for the loads specified on the winch, or in bad condition.
- insert objects into the moving parts.
- service winches while they are loaded or receiving power.
- use the rope of the machine as a sling.
- tap on the control box (heating the motor and the electrical controls).

3 – Compulsory regulatory inspections by the user

This equipment has been designed to be subjected to the following tests:

- Dynamic proof test at coefficient 1.1
- Static proof test at coefficient 1.25

Users are required to conform to the regulations in force in their own countries.

In the case of France:

Order of 1 March 2004 on the testing of lifting machines and accessories:

The amendments to the regulations regarding the use and testing of lifting machines and accessories, in force since 1 April 2005, impose new obligations on all users:

- Adaptation exam, which consists of checking that the lifting machine is suitable for the work the user intends to carry out as well as for the risks to which the workers are exposed and that the planned operations are compatible with the conditions for using the machine as defined by the manufacturer.
- Assembly and installation exam, which consists of making sure that the lifting machine is assembled and installed in a safe manner, in accordance with the manufacturer's instruction manual.

- Periodic general inspections, including an exam of the state of conservation and operating tests.
- Tests for starting or restarting service in the event of changing the operation site, changing the configuration or the conditions for use on the same site, following dismantlement and reassembly of the lifting machine, after any considerable replacement, repair or transformation affecting the core components of the lifting machine, following any accident caused by a failure in a core component of the lifting machine.
- The tests must be performed in strict observance of protocol. They aim to provide preventive maintenance, detecting any damage or faults that can create a risk.

VERLINDE provides an upkeep / maintenance manual for each piece of equipment. It is very important to make sure that the individuals using the hoist are familiar with the equipment and its correct operation.

VERLINDE agencies are available and may, upon request or by contract, intervene and maintain the winch if necessary.

If any replacement parts are needed, please specify the following information so that we may supply the appropriate parts:

- the complete name of the winch
- the complete name of the hoisting motor if necessary
- the serial number of the winch

The 3 items above are listed on the ID plates attached to the winch, motors and on the inspection certificates.

For further information, please contact the winch manufacturer or the distributor.

Manufactured by :

Manufactured by:VERLINDE
VERNOUILLET- FRANCE
2, Boulevard de l'industrie
B.P. 59 28501 VERNOUILLET CEDEX
Phone: +33 (0)2.37.38.95.95
Fax: +33 (0)2.37.38.95.99

4 – Introduction to the machines

4.1 - General

These winches are designed for pulling or lifting loads from 1000 to 10000 kg.
Their FEM classification is 1 Am (ISO: M4)

The TVI Series winches are equipped with the following:

- Reduction gear with planetary gears, completely watertight.
- Motor 1 speed, three-phase 230/400 V 50 Hz, protection rating IP 55. Operating limits from -10°C to +50°C (without declassification).

24 V very-low voltage control including:

- Contactors
- Power line isolator
- Thermal circuit breaker
- Disconnectable button box (2 buttons + emergency stop), 3 m of cable.

Very-low voltage control with variable speed drive (compulsory above 5 tons), comprising:

- Power line isolator
- Variable-frequency drive
- Braking resistance
- Button box (2 buttons + emergency stop + potentiometer), not disconnectable, 3 m of cable.

4.2 - Dimensions

Depending on models :

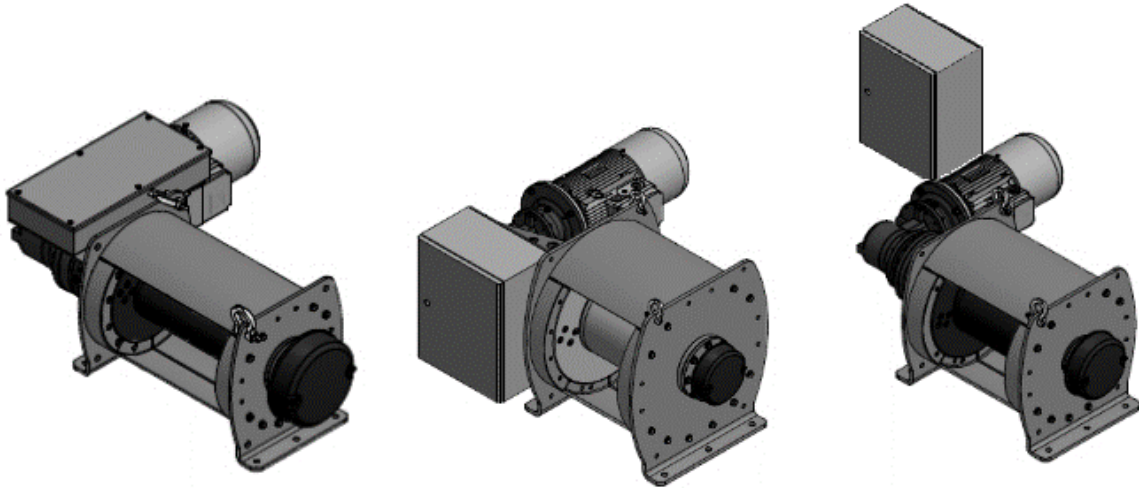

Above the motor (1)

on its side (2)

or away (3)

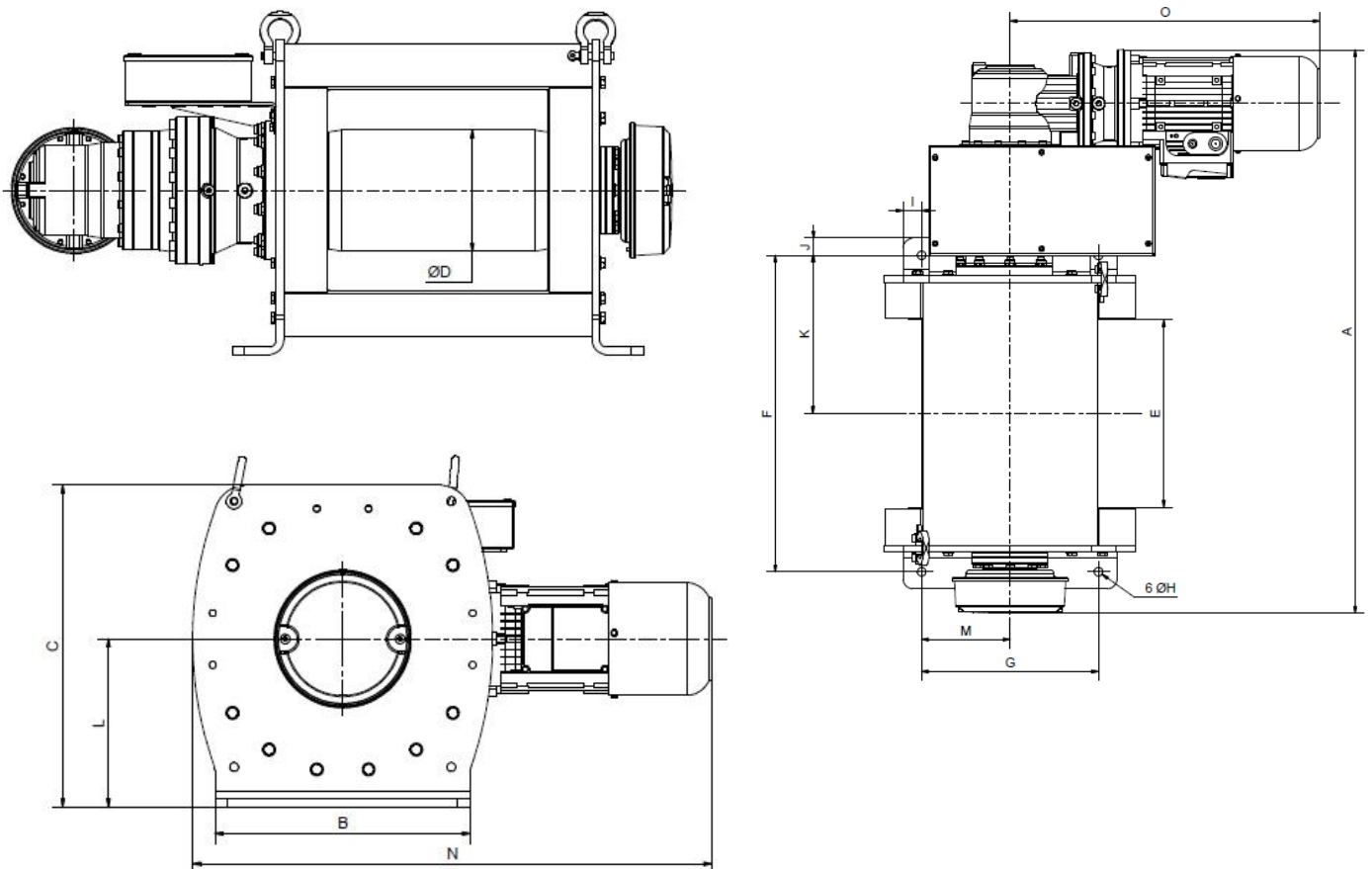

a. Low voltage control – Models with 1 speed

TVI	1 T	2 T	3 T	4 T	5 T	6 T	7 T	8 T	9 T	10 T
	05BT/10BT	05BT/09BT	03BT/06BT	02BT/05BT	03BT/07BT	02BT/06BT	02BT/06BT	02BT/05BT	02BT/05BT	03BT/05BT
Position of the electrical unit	(1)	(1)	(1)	(1)	(1) / (2)	(1) / (3)	(1) / (2)	(1) / (2)	(1) / (2)	(1) / (2)
A in mm	911	1050/1045	1065/1090	1169/1194	1194/1220	1224/1250	1241/1267	1241/1267	1288/1087	1314/1288
B in mm	290	420	420	520	520	650	700	700	840	840
C in mm	375	500	500	665	665	765	870	870	975	975
∅ D in mm	125	219,1	219,1	292	292	323,9	355,6	355,6	406,4	406,4
E in mm	350	350	350	350	350	350	350	350	350	350
F in mm	525	590	590	600	600	600	720	720	720	720
G in mm	240	330	330	420	420	420	620	620	750	750
∅ H en mm	12	16	16	22	22	22	30	30	32	32
I in mm	25	45	45	50	50	115	40	40	45	45
J in mm	23	32	32	30	30	30	50	50	47	47
K in mm	263	295	295	300	300	300	360	360	360	360
L in mm	188	262	262	350	350	395	455	455	515	515
M in mm	120	165	165	210	210	210	310	310	375	375
N in mm	716/748	823/902	823/902	905/984	954/1190	1013/1181	1103/1271	1133/1271	1176/1314	1176/1314
O in mm	548/578	578/657	578/657	578/657	627/795	627/795	662/830	692/830	692/830	692/830

b. Low voltage control – Models with frequency inverter

TVI	1 T	2 T	3 T	4 T	5 T	6 T	7 T	8 T	9 T	10 T
	05VV/10VV	05VV/09VV	03VV/06VV	02VV/05VV	03VV/07VV	02VV/06VV	02VV/06VV	02VV/05VV	02VV/05VV	03VV/05VV
Position of the electrical unit	(1)	(1) / (3)	(1) / (3)	(1) / (2)	(2) / (3)	(2)	(2)	(2)	(2)	(2)
A in mm	911	1050/1045	1065/1090	1169/1194	1194/1220	1224/1250	1241/1267	1241/1340	1288/1087	1288/1367
B in mm	290	420	420	520	520	650	700	700	840	840
C in mm	375	579/500	579/500	737/665	665	765	870	870	975	975
∅ D in mm	125	219,1	219,1	292	292	323,9	355,6	355,6	406,4	406,4
E in mm	350	350	350	350	350	350	350	350	350	350
F in mm	525	590	590	600	600	600	720	720	720	720
G in mm	240	330	330	420	420	420	620	620	750	750
∅ H en mm	12	16	16	22	22	22	30	30	32	32
I in mm	25	45	45	50	50	115	40	40	45	45
J in mm	23	32	32	30	30	30	50	50	47	47
K in mm	263	295	295	300	300	300	360	360	360	360
L in mm	188	262	262	350	350	395	455	455	515	515
M in mm	120	165	165	210	210	210	310	310	375	375
N in mm	716/748	823/902	823/902	905/1052	1022/1122	1067/1220	1103/1271	1133/1271	1176/1314	1176/1314
O in mm	548/578	578/657	578/657	578/657	627/795	627/795	662/830	692/830	692/830	692/830

4.3 - Models available

Warning:

- . the rope diameter shown above corresponds to the recommended rope according to FEM 1 Am / ISO M4 classification. It also corresponds to the capacity on the last layer.
- . it is compulsory to ensure that the resistance coefficient of the rope complies with the lifted load (FEM 1 Am / ISO M4).

TVI	Low voltage control – Models with 1 speed									
	1 T		2 T		3 T		4 T		5 T	
	05BT	10BT	05BT	09BT	03BT	06BT	02BT	05BT	03BT	07BT
Capacity on the 1rst layer kg	1255		2420		3765		4985		6230	
Capacity on the last layer (kg)	1000		2000		3000		4000		5000	
Nb of layers	3		3		3		3		3	
Wire rope capacity at 1rst layer m *	17		20		16		16		16	
Max. rope capacity (m)	60		71		59		60		60	
Rope diameter (mm)	8		11,5		14		18		18	
Speed on the 1rst layer m/min	4	8,5	4,5	8	2,5	4,5	2	3,5	2,5	6
Speed on the last layer (m/min)	5	10,5	5,5	9,5	3,5	5,5	2,5	4,5	3	7,5
FEM	1Am		1Am		1Am		1Am		1Am	
Motor (kW)	1,1	2,2	2,2	4	2,2	4	2,2	4	3	9,2
Supply	3 Ph - 230/400 V		3 Ph - 230/400 V		3 Ph - 230/400 V		3 Ph - 230/400 V		3 Ph - 230/400 V	
Weight (winch without wire rope) kg	140	150	260	280	260	280	440	470	450	530

TVI	Low voltage control – Models with 1 speed									
	6 T		7 T		8 T		9 T		10 T	
	02BT	06BT	02BT	06BT	02BT	05BT	02BT	05BT	03BT	05BT
Capacity on the 1rst layer kg	7480		8725		9975		11120		12355	
Capacity on the last layer (kg)	6000		7000		8000		9000		10000	
Nb of layers	3		3		3		3		3	
Wire rope capacity at 1rst layer m *	16		15		15		16		16	
Max. rope capacity (m)	60		60		60		62		62	
Rope diameter (mm)	20		22		22		24		24	
Speed on the 1rst layer m/min	1,5	5	1,5	4,5	2	4	1,5	4	2	3,5
Speed on the last layer (m/min)	2	6	2	5,5	2,5	5	2	4,5	2,5	4,5
FEM	1Am		1Am		1Am		1Am		1Am	
Motor (kW)	3	9,2	3	9,2	4	9,2	4	9,2	5,5	9,2
Supply	3 Ph - 230/400 V		3 Ph - 230/400 V		3 Ph - 230/400 V		3 Ph - 230/400 V		3 Ph - 230/400 V	
Weight (winch without wire rope) kg	580	660	840	910	850	910	1160	1230	1180	1230

TVI	Low voltage control – Models with frequency inverter									
	1 T		2 T		3 T		4 T		5 T	
	05VV	10VV	05VV	09VV	03VV	06VV	02VV	05VV	03VV	07VV
Capacity on the 1rst layer kg	1255		2420		3765		4985		6230	
Capacity on the last layer (kg)	1000		2000		3000		4000		5000	
Nb of layers	3		3		3		3		3	
Wire rope capacity at 1rst layer m *	17		20		16		16		16	
Max. rope capacity (m)	60		71		59		60		60	
Rope diameter (mm)	8		11,5		14		18		18	
Speed on the 1rst layer m/min	4	8,5	4,5	8	2,5	4,5	2	3,5	2,5	6
Speed on the last layer (m/min)	5	10,5	5,5	9,5	3,5	5,5	2,5	4,5	3	7,5
FEM	1Am		1Am		1Am		1Am		1Am	
Motor (kW)	1,1	2,2	2,2	4	2,2	4	2,2	4	3	9,2
Supply	3 Ph - 230/400 V		3 Ph - 230/400 V		3 Ph - 230/400 V		3 Ph - 230/400 V		3 Ph - 230/400 V	
Weight (winch without wire rope) kg	150	155	270	300	270	300	450	500	480	540

TVI	Low voltage control – Models with frequency inverter									
	6 T		7 T		8 T		9 T		10 T	
	02VV	06VV	02VV	06VV	02VV	05VV	02VV	05VV	03VV	05VV
Capacity on the 1st layer kg	7480		8725		9975		11120		12355	
Capacity on the last layer (kg)	6000		7000		8000		9000		10000	
Nb of layers	3		3		3		3		3	
Wire rope capacity at 1st layer m *	16		15		15		16		16	
Max. rope capacity (m)	60		60		60		62		62	
Rope diameter (mm)	20		22		22		24		24	
Speed on the 1st layer m/min	1,5	5	1,5	4,5	2	4	1,5	4	2	3,5
Speed on the last layer (m/min)	2	6	2	5,5	2,5	5	2	4,5	2,5	4,5
FEM	1Am		1Am		1Am		1Am		1Am	
Motor (kW)	3	9,2	3	9,2	4	9,2	4	9,2	5,5	9,2
Supply	3 Ph - 230/400 V		3 Ph - 230/400 V		3 Ph - 230/400 V		3 Ph - 230/400 V		3 Ph - 230/400 V	
Weight (winch without wire rope) kg	610	670	870	920	880	920	1190	1250	1210	1250

* Rope and hook extra.

The diameter of the wire rope corresponds to the capacity on the last layer

4.4 - Options

The TVI Series winches can be supplied with the following options:

- Clock-type limit switch
Easily adjustable, this system guarantees safety by setting top and bottom limits.
- IP 65 limit switch
- Electronic load limiter
Device with display which stops the winch in the event of an overload without breaking the kinematic chain.
- Slotted drum
Enables correct winding of the rope on the first layer.
- Secondary brake
- Emergency trouble shooting hand wheel
- Multi rope grooved drum
- Lower chassis
- Tarpauline cover
- Special paint (C4, C5M)
- Rope presser roller
Essential complement for the slotted drum if the rope is not permanently tight.
- Manual unblocking of the brake with automatic return
- Manual control
Handwheel or crank associated with a brake unblocking system.
- Rope-slack switch
Detects rope that is not under tension.
- 2nd rope attachment
Option for creating a back-and-forth system or for lifting a load at two points.
- Timer
Allows the user to add up the total time of winch operation and makes it easier to use the maintenance log.
- Phase order detector
Allows the winch not to be connected with raising / lowering inversion.
- Hauling radio control
- Adjustable speed drive hauling radio control
- Lifting radio control
- Proportional adjustable speed drive lifting radio control
- Any other requirements : consult us.

4.5 - Classification FEM

There are eight groups of mechanisms:

FEM	1 Dm	1 Cm	1 Bm	1 Am	2m	3m	4m	5m
ISO	M 1	M 2	M 3	M 4	M 5	M 6	M 7	M 8

To determine the group of a given lifting device, winch or hoist, three essential parameters must be considered:

4.5.1. - Maximum load to be lifted

Including the weight of the rope and any lifting accessories used (hook, etc.) unless these have a total weight equal to or less than 5% of the load to be lifted.

4.5.2. - Strain condition

Specifies the proportions in which the lifting machine is used with maximum load or reduced load. Four characterized strain conditions are identified in this way:

Light	Lifting machines exceptionally subjected to the maximum strain and commonly to very light strains.	$k \leq 0.5$
Medium	Lifting machines often subjected to the maximum strain and commonly to light strains.	$0.5 < k \leq 0.63$
Heavy	Lifting machines frequently subjected to the maximum strain and commonly to medium strains.	$0.63 < k \leq 0.8$
Very heavy	Lifting machines regularly subjected to the strains near to the maximum strain.	$0.8 < k \leq 1$

4.5.3. – FEM classification

Strain condition	Average operating time per day, in hours						
	30'	1 h	2 h	4 h	8 h	16 h	More than 16 h
Light	1 Dm	1 Cm	1 Bm	1 Am	2m	3m	4m
Medium	1 Cm	1 Bm	1 Am	2m	3m	4m	5m
Heavy	1 Bm	1 Am	2m	3m	4m	5m	
Very heavy	1 Am	2m	3m	4m	5m		

5 – Handling - Storage

When handling the winch, use slings that are compatible with the slinging points provided for this purpose on the winch.

Warning: the angle formed between the hook and the two slinging points must be at most 45°.

Lift and set down the winch with care, without letting it fall, bearing in mind the offset centre of gravity.

For further information on the weight of the winch, consult the Technical Specifications chapter.

These winches must be protected from the elements, in a dry and clean location, at temperatures comprised between -10°C and +50°C.

6 – Installation and start-up

6.1 – Fixings

The TVI Series winches must necessarily be installed on a flat, solid and safe surface that can withstand the loads to which it will be subjected. An unsuitable installation location can result in serious accidents.

To assess the suitability of an installation location and its load resistance, it is advisable to take into account any possible overloads, the weight of the actual winch as well as the weight of the optional components and/or accessories installed on it, including any dynamic forces. The winch operator is responsible for selecting the installation location. In the event of any doubts regarding the suitability of an installation location, consult a civil engineer or a stress and strain specialist.

Correctly tighten the fixing bolts (see tables 4.2 and 4.3)

Screw/Nut	Tightening torque screw / Nut quality 8.8 Nm
M10	51
M12	85
M14	140
M16	210
M20	410
M24	710

6.2 - Mains power supply

Very important: the winch will only operate with full power when the motor is correctly supplied with a suitable cable cross-section.

Provide voltage protection before the electric box.

An isolator must be installed at least 10 meters from the usage location.

6.3 - Adjusting the limit switch (optional)

The TVI Series winches are available with two types of limit switches:

Clock type: Remove the protective cover of the device (inside this cover you will find the diagram below). The levers, which are now accessible, can be turned manually.

- Adjustment of the winding stop point:
 - Wind the rope to the maximum desired winding point. Stop the winch.
 - Still in this position, manually move the red lever (2) to the lowest position of the rotation circle, where it activates the switch (3)

- Adjustment of the unwinding stop point:
 - Unwind the rope to the maximum desired unwinding point. Stop the winch.
 - Still in this position, manually move the black lever (1) to the lowest position of the rotation circle, where it activates the switch (3)

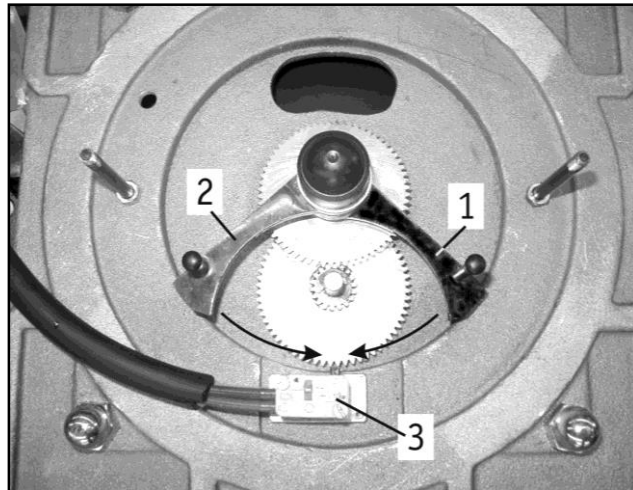

Type with IP65 cam: Remove the protective cover of the device, the cams (1) which are now accessible can be positioned with the help of a worm (2) using a screwdriver.

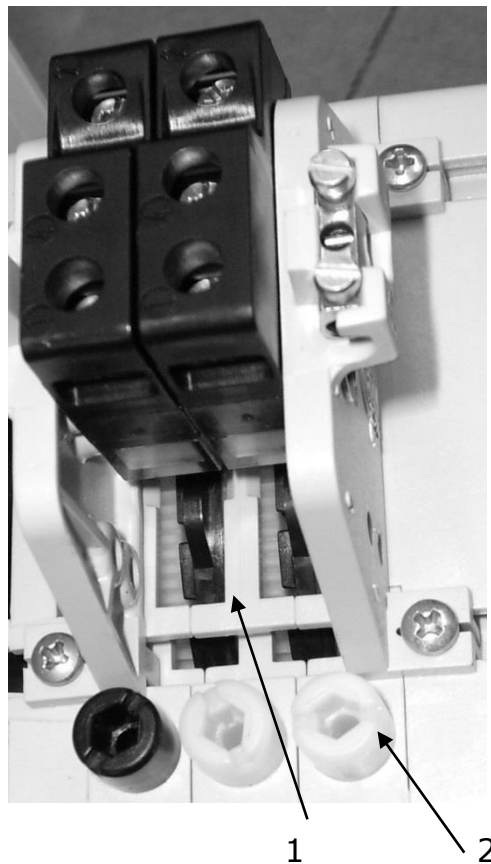

Each adjustment screw (2) corresponds to a TOP or BOTTOM limit position.
Adjustment of the top winding stop point:

Wind the rope to the maximum desired winding point. Stop the winch.
Still in this position, with the help of a suitable screwdriver, turn the adjustment screw (2) until a click is heard in the contactor.

Adjustment of the bottom unwinding stop point:

Unwind the rope until the bottom point, always leaving 3 safety turns on the drum. Stop the winch.

Still in this position, with the help of a suitable screwdriver, turn the adjustment screw (2) until a click is heard in the contactor.

This range of limit switches also includes a model with 4 positions.
If you need more positions, do not hesitate to consult us.

6.4 - Working rope

Warning: the direction of rotation of the drum depends on the connection of the machine.
Reminder: check the maximum capacity of the winch (see Models available § 4.4).

Very important:

Safety regulations require 2 to 3 coils of rope to be left on the drum at all times.
To comply with the legislation, the rope should not exceed the recommended diameter.
Make sure the rope and hook used guarantee a safety level corresponding to the table in §4.4 if they were not supplied by the manufacturer with the machine.

The useful life of the steel ropes used on the winch depends on many factors, including the conditions of the work cycles (lifting height, lifting speed, number and type of deviations, etc.) as well as the operating mode (number of winding layers, working cycle distribution along the length of the steel rope, etc.). The potential useful life of the steel ropes is therefore subject to considerable variations according to these points.

It is important to remember that any replacement ropes must use materials with the same characteristics as the original rope.
This replacement must be included in the maintenance log.

Measuring the rope diameter:

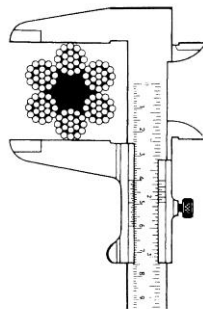

Correct measurement
with slide caliper

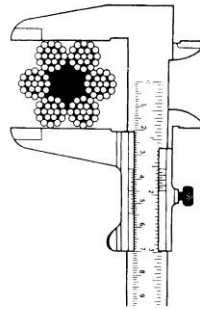

Incorrect measurement

Handling of steel ropes:

- Always use suitable protective gloves when handling steel ropes
- Never use any ropes that have defects such as:
 - ✓ An unacceptable number of broken strands
 - ✓ Birdcaging
 - ✓ Birdcaging
 - ✓ Flattening
 - ✓ Shrinkage
 - ✓ Strand extrusion
 - ✓ Broken cable cores
 - ✓ Slack strands
 - ✓ Bends or kinks
- Always check the rope for wear before using it.
- Never use steel ropes as loops
- Never expose the steel ropes to jagged lips or sharp edges

Unwinding the rope on its reel:

CORRECT

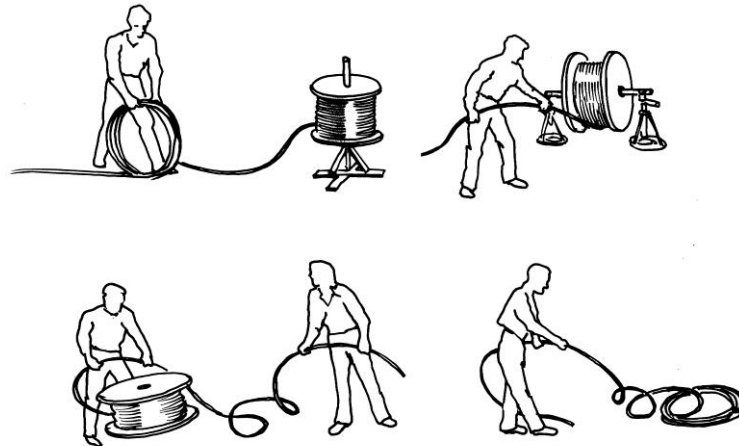

INCORRECT

Fixing the rope :

The ropes are supplied as standard with a rope attachment suitable for the recommended rope and installed according to a standard rope outlet.

Align the rope clamp with the hole made in the winch for this purpose.

Pass the rope through the slot of the flange and place it between the flange and the rope clamp, taking care to position it correctly in the rope clamp slot. Make the rope exceed the limit of the outer diameter of the flange.

Once the 4 screws are correctly tightened, the rope is properly installed.

The rope should not form loops in any case.

Winding the rope on the drum :

Tension the rope and wind it around the drum in close joining coils.

Check the winding direction of the rope according to the motor connection.

Start to wind the rope forming a spiral to the right. In order to facilitate this operation, some drums are provided with a heel attached to one of the flanges, which "fills" the space between the first turn and the flange.

The first layer must be wound in a compact manner and under tension. Take a mallet or a block of wood and knock the turns against one another; not too hard to prevent the strands from overlapping one another, but tightly enough to prevent the rope from moving on the drum. If the first layer is wound too loose, the next layer will form a space in the first layer that will result in an open area. If the first layer is too tight, the subsequent layers will not have enough space between turns.

In any case, the first layer and all the other layers must be wound onto the drum with enough pre-tension (5-10 % of the MWL of the rope). If the rope is wound without any tension, it will suffer from crushing and premature flattening caused by the loaded upper layers.

Even if the first layer is wound correctly during installation, it will expand a little while in service. When the first layer expands (loss of pre-tension) the initial procedure **MUST** be performed at regular intervals.

Otherwise, the "hard" turns will severely crush the base layers.

Whatever you do, **DO NOT** pass the rope through a clamping mechanism. For example, two blocks of wood screwed together. **THIS WILL CAUSE IRREPARABLE DAMAGE TO THE ROPE!**

Rope crossed to the right
Winding from left
to right

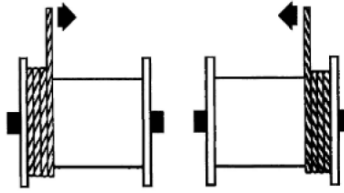

Rope crossed to the left
Winding from right
to left

Rope crossed to the right
Winding from right
to left

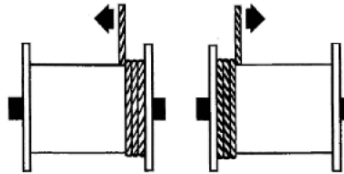

Rope crossed to the left
Winding from left
to right

Reeving diagrams :

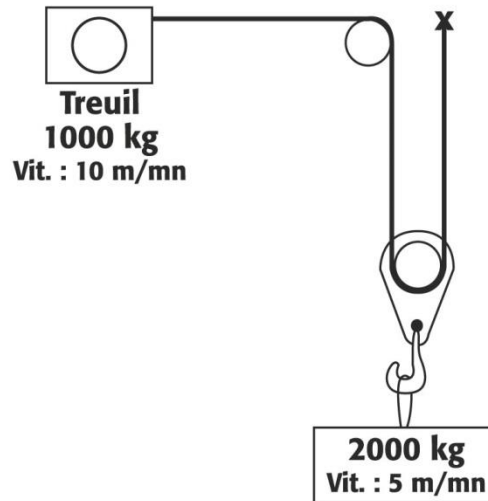

Bending angle :

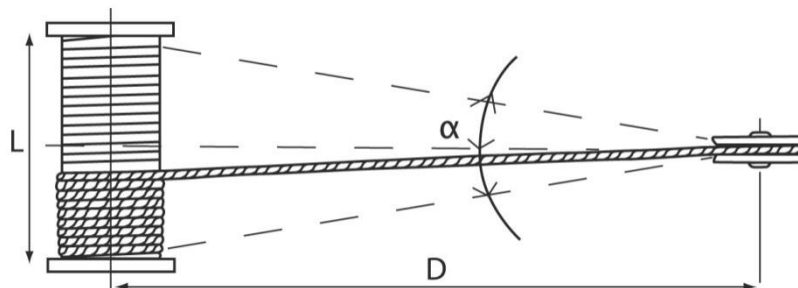

Smooth drum: $\alpha = \text{max. } 1.5^\circ$
Slotted drum: $\alpha = \text{max. } 2^\circ$
 $D = 20 \text{ times } L$

6.5 - Rope press roller

This option can be used to hold the rope in the slot of the drum. It has different positions according to the required rope outlet. It is therefore necessary to define the rope outlet for the control.

6.6 - Rope slack switch

This option can detect a loss of tension in the rope due to, for example, the load being set on the ground. It has different positions according to the required rope outlet. It is therefore necessary to define the rope outlet for the control

6.7- Load limiter (optional)

This device stops the winch in the event of an overload without the breakage of the kinematic chain. Compulsory when lifting loads over 1000 kg (Directive 2006/42/EC) in order to avoid rope breakage, structure deformation and accidents due to problems caused by overloading.

7 – Servicing and maintenance

Observe the following instructions, in particular if your winch is used in a large number of different locations or in a particularly dirty or humid environment:

- Remove as much dirt as possible from the winch.
- Always store the winch in a dry and clean location.

7.1 - Before starting up, check the following

- The oil level of the reduction gear
- The fixing of the rope on the drum.
- The external appearance of the winch.

7.2 - First start-up

At the start of the installation, you are advised to observe a running-in period at $\frac{3}{4}$ of the load for approximately thirty hours. The rated force is obtained after this running-in period.

7.3 - Periodic service

Every 100 hours, check the oil level of the reduction gear.

Every 500 hours, drain the reduction gear.

The reduction gear must be lubricated using Esso Glycolub Range 220 mineral oil (or equivalent).

Model	Amount (liters)
TVI 1T	1,7
TVI 2T – 3T	2,3
TVI 4T – 5T	3,3
TVI 6T	4
TVI 7T – 8T	7
TVI 9T – 10T	9

Very important:

If you change the type of oil, please contact our after-sales department.

Bearing lubrication: every 100 hours.

Ropes

The ropes must be cleaned and lubricated regularly using a special lubricant that penetrates to the cable core. Only use cleaning products that are suitable and harmless for all the components of the rope, including the core. If greasing cannot be carried out due to operational reasons, its useful life will be noticeably shorter and it will therefore necessary to increase monitoring of the rope.

The ropes must be checked visually every day.

Hooks

Check the hook and its safety catch.

If the rope and the hook are not supplied by the manufacturer, check that they guarantee a safety level corresponding to the table in §4.4.

Check the snatch block fastening points on a regular basis.

8 - Decommissioning

Once the equipment has reached an age at which it may pose hazards, the user is obliged to dispose of the equipment, i.e. taking it out of operation and dismantling it if required.

9 – Spare parts

If during the maintenance operations you detect that certain parts of your winch need to be replaced, only use original VERLINDE parts.

When ordering spare parts, please provide the following information with your order:

- Type and capacity of the winch (on the data plate).
- Serial number and year of manufacture (on the data plate)
- Number or name of the required parts (exploded views).

10 – Troubleshooting

Fault	Possible cause	Solution
Motor does not start.	Power supply interrupted.	Check and correct the problem. Check the emergency stop.
	The brake does not unblock	See "brake fault"
	The contactor does not respond, Fault in the control.	Check the contactor control and Get rid of the error.
	Limit switch triggered.	Check the limit switch.
Motor does not start or has difficulty starting.	The voltage or the frequency are very different from the set values when starting the motor.	Improve the mains conditions. Check the cable cross-sections.
The motor purrs and consumes a lot of current.	The brake does not unblock	See "brake fault"
	Faulty winding.	Take the motor to an authorized service center for repairs.
	A power supply phase is missing.	Check the power supply.
Circuit breaker trips instantly.	Short-circuit in the power cables.	Get rid of the short-circuit.
	Short-circuit in the motor.	Have the fault corrected at an authorized service center,
	Power cables not connected correctly.	Correct the connection.
	Motor ground fault.	Have the fault corrected at an authorized service center,
Speed considerably reduced under load.	Voltage drop.	Increase the cross-section of the power cable.
Motor overheating (temperature measurement)	Insufficient ventilation.	Free up the ventilation shafts.
	Excessively high ambient temperature.	Observe the authorized temperature range.
	Poor contact of the power cable (temporary operation with 2 phases)	Get rid of the poor contact.
	Circuit breaker tripped.	Poor contact on the relays.
	Service factor exceeded (S1 to S10, DIN 57530), e.g. due to an excessively high start-up rate.	Adapt the service factor to the recommended conditions and, if necessary, call a specialist to determine the motor.
Excessively noisy drive	Vibration of the rotating elements.	Check the balance and get rid of the cause of the vibrations.
	Foreign bodies in the ventilation shafts.	Clean the ventilation shafts.
The brake does not unblock	Incorrect voltage in the brake rectifier.	Apply the voltage specified on the data plate.
	Faulty brake control.	Replace the brake control, check the brake coil (internal resistance and insulation) and the relays.
	Max. air gap exceeded due to wear of the linings.	Measure and, if necessary, correct the air gap.
	Voltage drop > 10% of input power.	Guarantee correct power supply, check the cable cross-section.
	Short to frame or between the turns.	Have the complete brake including rectifier replaced at an authorized service center, check the relays.
	Faulty rectifier.	Replace the brake coil and rectifier.
The motor does not brake.	Incorrect air gap.	Measure and, if necessary, correct the air gap.
	Brake linings completely worn.	Replace the entire backplate.

12 – Appendixes

- A – References of parts
- B – Load limiter
- C - Limit switch (optional)

A - References of parts

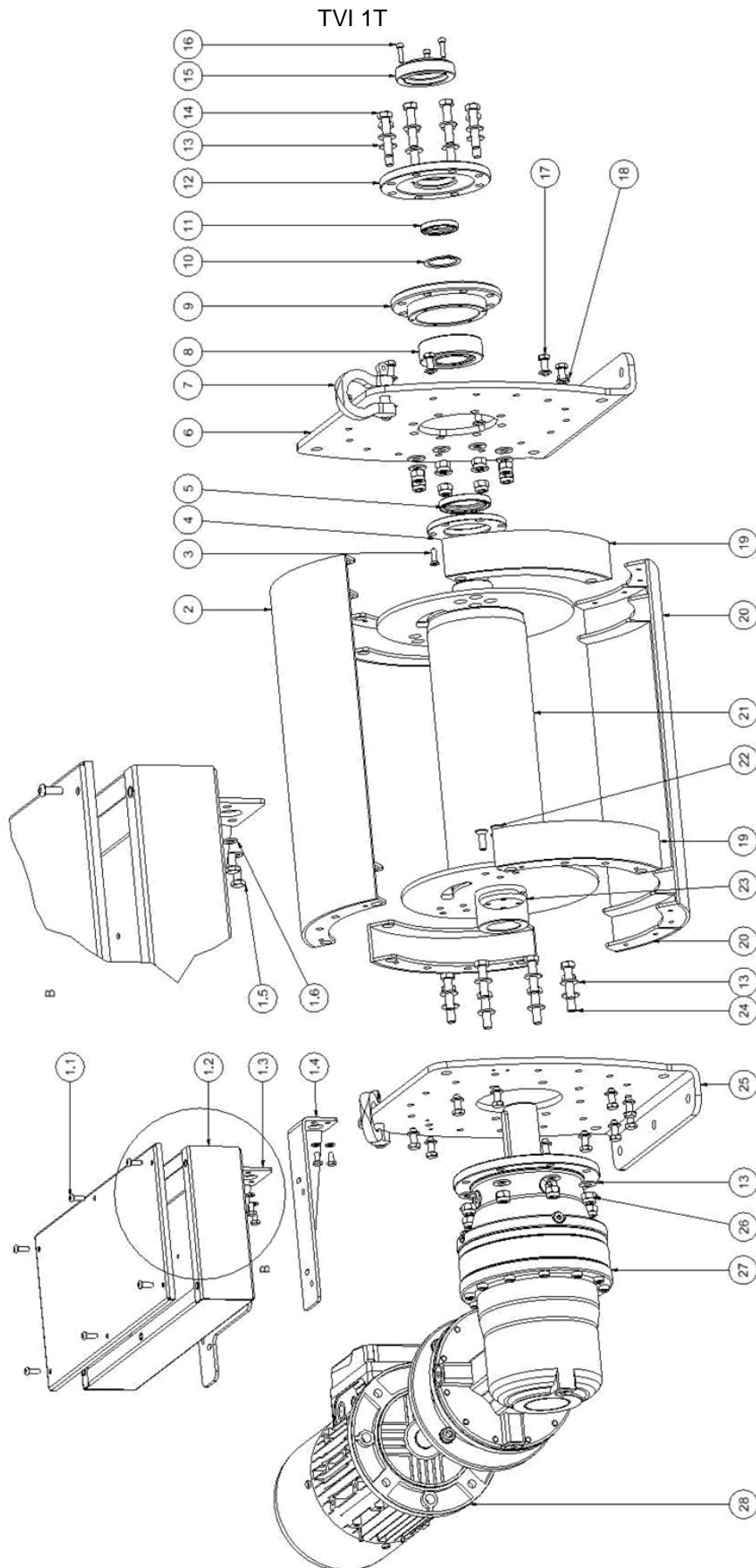

Key	Designation	Winch reference	
		TVI 1T 05	TVI 1T 10
1	Electrical cabinet BT	151050	
	Electrical cabinet VV	151051	
2	Tie rode	24096	
3	Screw	13541	
4	Plate	23316	
5	Seal	2955	
6	Support	24091	
7	Crank	MANILLELYRE600KG	
8	Bearing	2953	
9	Housing	23315	
10	Spring retaining ring	13048	
11	Seal	2954	
12	Crank	23317	
13	Washer	13306	
14	Screw	13078	
15	Hub cap	24095	
16	Screw	13124	
17	Screw	13065	
18	Washer	13210	
19	Protection	24097	
20	Tie rode	24092	
21	SE drum	24093	
22	Screw	13168	
23	Cable clamp	24126	
24	Screw	13334	
25	Support	24090	
26	Nut	13020	
27	Reduction gear	24070	24071
28	Motor	24190	24191

TVI 2T & 3T

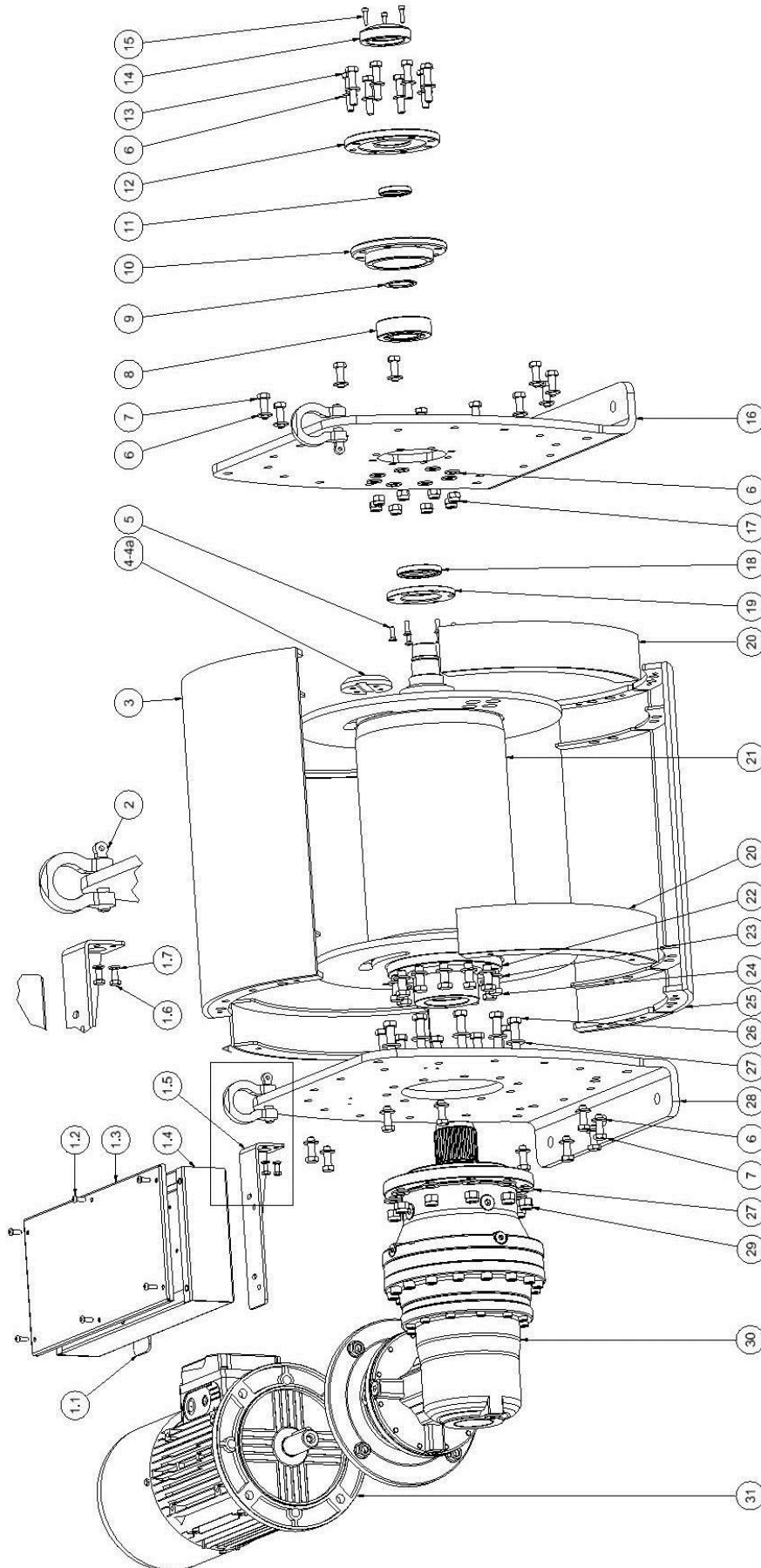

Key	Designation	Winch reference			
		TVI 2T05	TVI 2T09	TVI 3T0T	TVI 3T06
1	Electrical cabinet BT	151050	151009	151050	151009
	Electrical cabinet VV	151051	151056	151051	151056
2	Crank	MANILLELYRE600KG			
3	Tie rode	24103			
4	Cable clamp	23430			
4a	Screw	13112			
5	Screw	13541			
6	Washer	13306			
7	Screw	13076			
8	Bearing	2953			
9	Spring retaining ring	13048			
10	Housing	23315			
11	Seal	2954			
12	Flange	23317			
13	Screw	13078			
14	Hub cap	24095			
15	Screw	13124			
16	Support	24101			
17	Nut	13020			
18	Seal	2955			
19	Plate	23316			
20	Protection	24104			
21	SE drum	24121			
22	Tie rode	WF062			
23	Screw	13212			
24	Washer	13083			
25	Plate	24105			
26	Protection	13087			
27	Drum	13212			
28	Support	24100			
29	Nut	13433			
30	Reduction gear	24072	24073	24074	24075
31	Motor	24191	24192	24191	24192

TVI from 4T to 10T

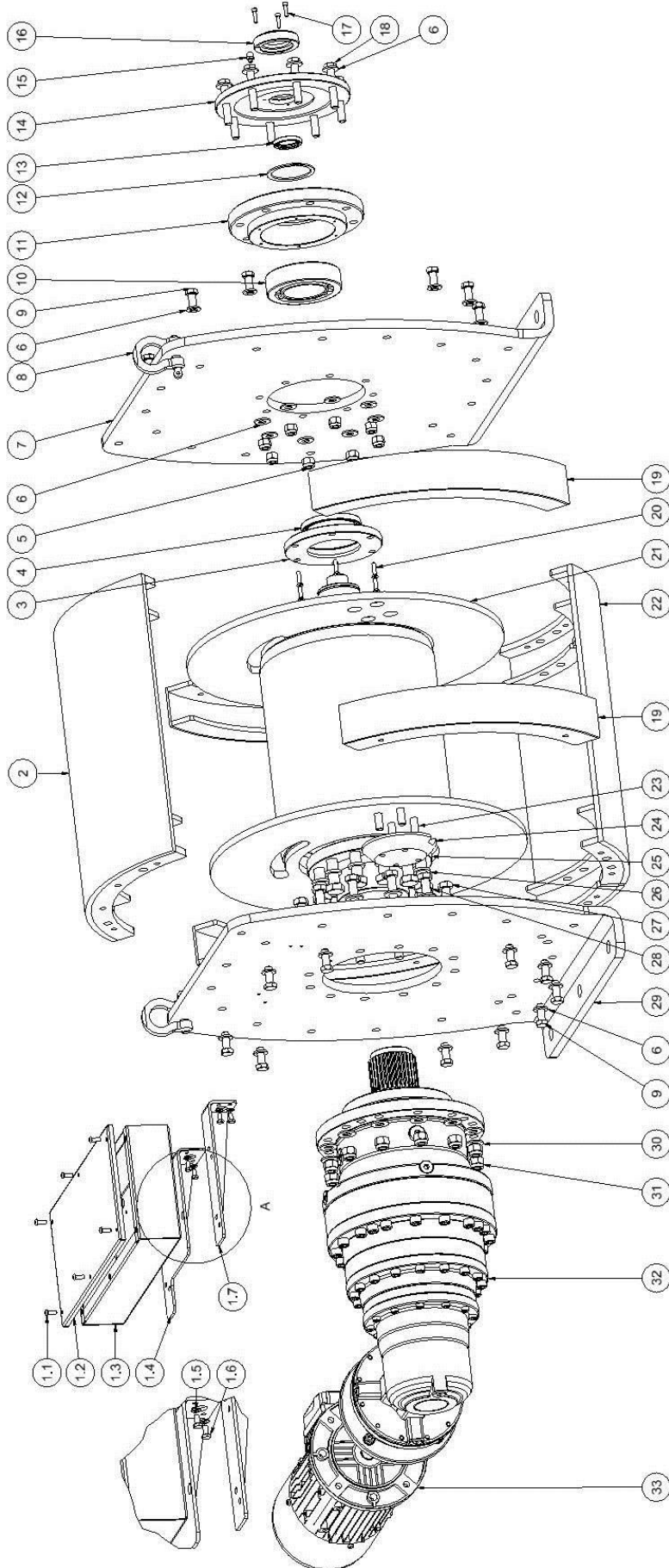

Key	Designation	Winch reference													
		4T 02	4T 05	5T 03	5T 07	6T 02	6T 06	7T 02	7T 06	8T 02	8T 05	9T 02	9T 05	10T 03	10T 05
1	Electrical cabinet BT	151050	151009	151009	151067	151009	151067	151009	151067	151009	151067	151009	151067	151061	151067
	Electrical cabinet VV	151051	151056	151056	151068	151056	151068	151056	151068	151056	151068	151056	151068	151062	151068
2	Tie rode	24133				24153		24163				24173			
3	Plate	24131				24131		24131				23376			
4	Seal	2989				2989		2989				2958			
5	Nut	13433				13433		13433				13485			
6	Washer	13212				13212		13212				13214			
7	Support	24129				24159		24169				24179			
8	Crank	MANILLELYRE600KG				-----		-----				-----			
9	Screw	13083				13083		13096				13097			
10	Bearing	3160				3160		3160				2961			
11	Housing	24130				24130		24130				23375			
12	Spring retaining ring	13729				13729		13729				2957			
13	Seal	3047				3047		3047				2954			
14	Flange	24136				24136		24136				23377			
15	Greaser	2960				2960		2960				2960			
16	Hub cap	24095				24095		24095				24095			
17	Screw	13124				13124		13124				13124			
18	Screw	13089				13089		13089				13415			
19	Protection	24134				24154		24164				24174			
20	Screw	13526				13526		13526				13541			
21	SE drump	24132				24152		24162				24172			
22	Tie rode	24135				24155		24165				24175			
23	Screw	13638				13671		13671				13657			
24	Cable clamp	22676				23442		23442				23434			
25	Bride	WF080				WF090		WF100				WF120			
26	Washer	13307				13214		13217				13217			
27	Screw	13700				13099		13419				13497			
28	Screw	13412				13097		13632				13632			
29	Support	24128				24158		24168				24178			
30	Washer	13213				13214		13214				13214			
31	Nut	13022				13485		13485				13485			
32	Reduction gear	24076	24077	24078	24079	24080	24081	24082	24083	24084	24085	24086	24087	24088	24089
33	Motor	24191	24192	24193	24194	24193	24194	24193	24194	24192	24194	24192	24194	24195	24194

B – Limit switch

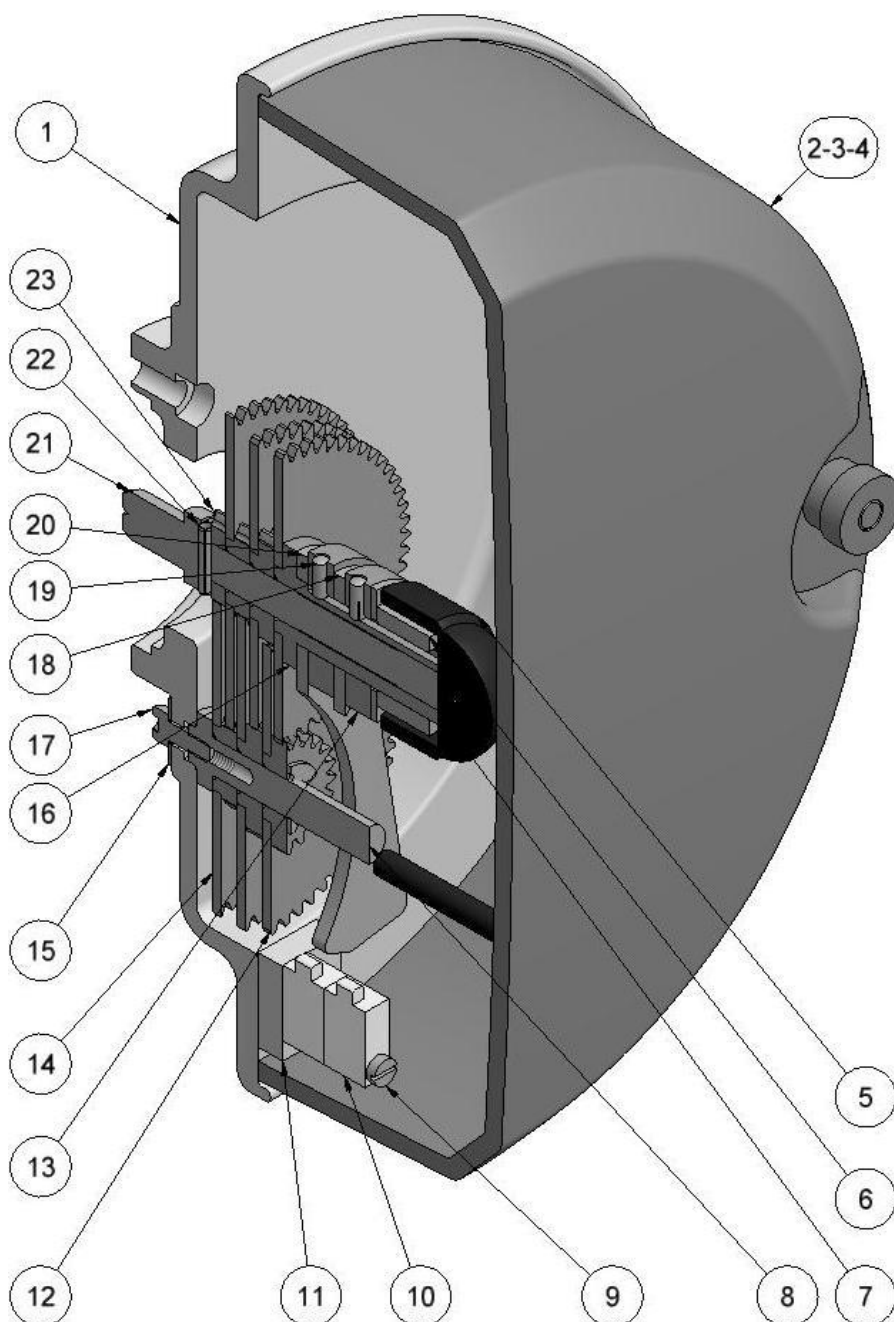

Item	Reference	Name
1	20886	Base
2	4907	Cover
3	4909	Captive nut
4	4908	Tie rod
5	3036	Cap
6	13023	Nut
7	13244	Circlips
8	20883	Intermediate pin
9	13244	Screw
10	3683	Contact
11	20781	Wedge
12	4914	Cannon pinion sub-assembly

Item	Reference	Name
13	20787	Spacer
14	4912	Intermediate pinion sub-assembly
15	13370	Washer
16	4925	Cannon pinion pin
17	13121	Screw
18	4939	Top index sub-assembly
19	3025	Pin
20	4940	Bottom index sub-assembly
21	20884	Cannon pinion pin
22	13384	Pin
23	4915	Entry pinion

C – Load limiter

a) With CROUZET load limiter

The winch is adjusted in the factory with the electrical voltage indicated on the test report enclosed with this instruction manual. If this voltage is different in the place of use, the setting must be readjusted.

In the event of overloading of the winch, a load limitation by motor current measurement cuts the lift control. Once you have identified and eliminated the cause of the load limiter activation, use the key-activated turning button on the right of the unit to reset the load limiter and use the winch again.

Adjust the sensitivity of the load limiter by adjusting the "I value" on the limiter using a small slotted screwdriver:

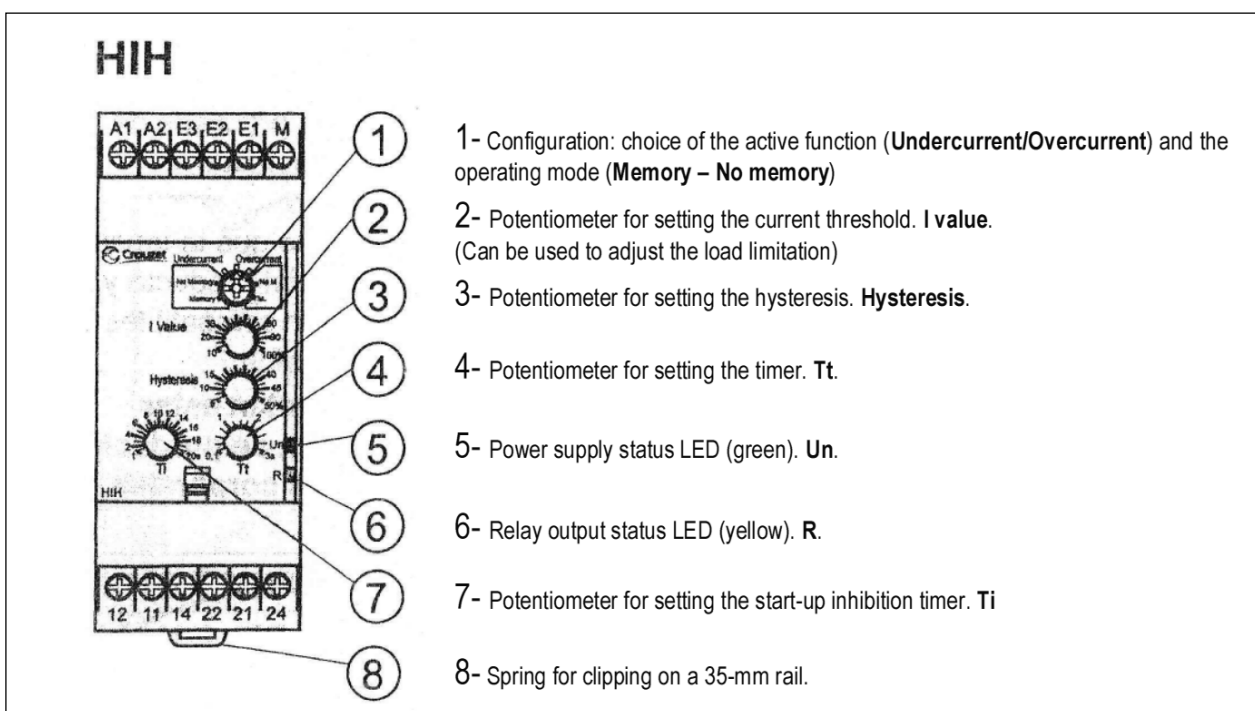

The load limiter is adjusted in the factory to the value of about 110% of its MCU.

IMPORTANT!

- Setting the threshold too high may lead to major risks both for the equipment and the operators.

DANGER: RISK OF ELECTROCUTION, EXPLOSION OR ELECTRIC ARC.

Switch the power off before installing, wiring or performing a maintenance operation. Check that the power supply voltage of the product, with its tolerances, is compatible with that of the network.

Non compliance with this instruction will cause death or serious injury.

WARNING: UNEXPECTED OPERATION OF THE EQUIPMENT

Please do not disassemble, repair or modify the product. Respect the installation and operating conditions of the product described in this document.

Non compliance with this directive may cause death, serious bodily injury or material damage.







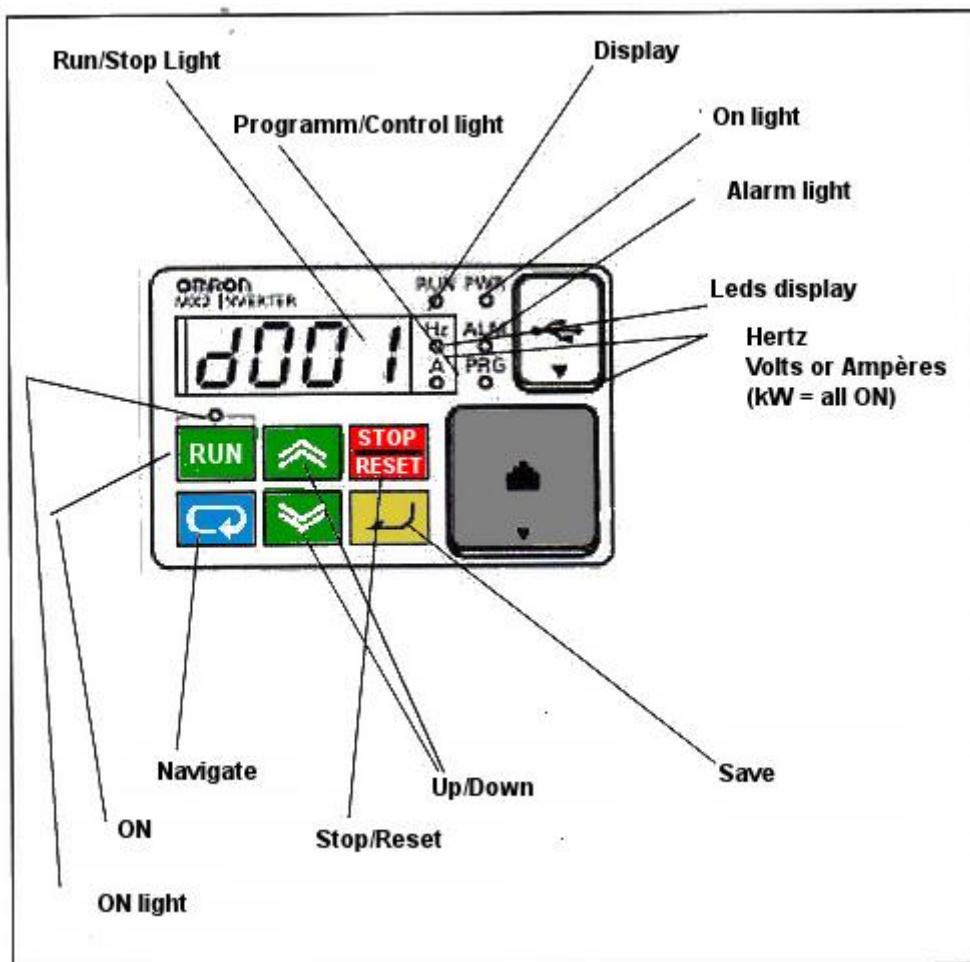

Electrical equipment must be installed, operated and serviced by qualified personnel.











b) With speed inverter (model TVI VV)

Use of the integrated keyboard



Setting of the limit (current) by the inverter:

- 1/ Winch turned on display 0000, key **save** .
- 2/ Key **navigate**  multiple pulses to display **C001**.
- 3/ Key **Up**  until **C041**.
- 4/ Key **Save** .
- 5/ A value in Amps is displayed: increase a maximum with the key **up** , Then the key **save** .
- 6/ Key **navigate**  to display **D001**.
- 7/ Key **up**  until **D002** (reading of the current in Amps).

- 8/ Key **save** . **0000** is displayed. (Load the winch to the desired cutoff value).
- 9/ Operate the rise (online reading of the Amps). Example 5A at XX kg cutoff desired.
- 10/ back in **C041** with the key **save** , then **navigate** , **save**  and then **up** . Setting at 5A (example) with the key **up**  or **down**  and **save** .
- 11/ Key **navigate**  **D001** then **save**  and use.



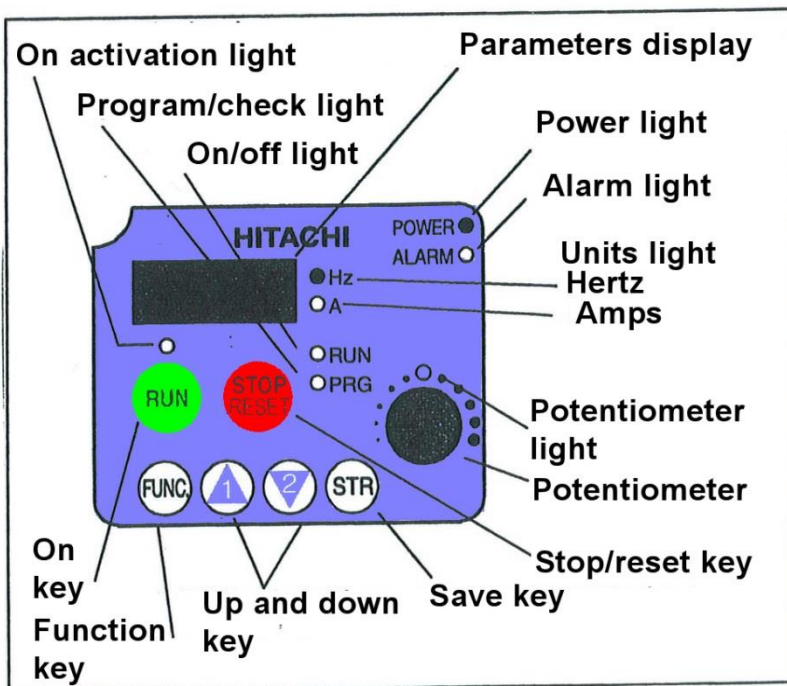

The default reset **E12** is made by the stop reset key  or the key switch on the electrical cabinet.

c) With SJ200 variator

Use of the integrated keyboard







Setting of the current limitation via the speed inverter SJ200 :



- 1/ Winch turned on display **0000**, key  display **D001**.
- 2/ Arrow **2** = **H** - - - .
- 3/ Arrow **2** = **C** - - - .
- 4/ Key  = **C001** the arrow **1** until **C041**.
- 5/ Key  display the value in Amps, key  until maximum value. Then key  to validate.

6/ Key  back in **C041**, 3 successive press on key  for **C - - -**.

7/  for **D002** then key  display **0000** live reading of the Amps.

8/ Load the winch to the required value, then test and read the Amps (ex 5.00A).

9/ Back in **C041** to set the defined value in **D002** : key  +3 times on key , key  + tkey  until **C041** setting of the value (ex 5.00A or inferior for cut off below the reading) in Amps then key  to validate.

10/ Key  for **C - - -** then arrow **1** until **D001** then key  and key  to read the frequency.