

 **EXPERT Crane Components**

500 kg



FOOD PROCESS



Range of lifting material
for food industry

 **VERLINDE**[®]

LIFTING EQUIPMENT

Ref : 01 2015 135 UGB

Verlinde, leader in lifting equipment in Europe and worldwide

Each product bearing the VERLINDE brand is the outcome of production facilities that are constantly improved and adapted to cutting-edge design techniques.

The materials and components used for the manufacture of our products are subjected to the most stringent checks.

At its various production plants, VERLINDE mass produces wire rope, chain, belt electric winches, together with travelling crane components.

Sales agents well-acquainted with hoisting techniques analyse the problems

set by each installation project (10 agencies in France and other agencies and commercial operations in over 92 countries throughout the world).

A rapid answer to your problems : our sales agents can respond immediately to any request for standard equipment, whilst for more specialised queries, our Engineering Service will respond very rapidly.

Rush, one-off deliveries : the planning schedule is a key instrument in our activity - our plants are organised to meet out-of-the-ordinary requests.



500 kg

Top quality materials for extremes conditions

The VERLINDE's range of lifting equipment for Food Process application is specially designed for use in food industry area.

By procuring all the components of your lifting rig (jib, hoist, winch, cable, etc.) from the same supplier, you can be sure of the rigorous quality and perfect match-up of the entire assembly.

Once the lifting rig is installed, you will discover that servicing is kept to a strict minimum. The combination of materials that are both extremely robust

and lightweight, along with the ease-of-use of our products, facilitates not only maintenance but also keeps down the number of operators required for doing the work.

The Food Process range from VERLINDE is made out with non-corroding materials (INOX 316L, aluminium,...). Some model have an extra layer of protection via a coat of ceramic treatment, polyester, epoxy, epoxy-polyester paint to obtain surface treatment adapted to special working area.



A wide choice of lifting solutions dedicated to your need

HAND CHAIN BLOCK

For vertical lifting without horizontal motion. Hand chain block compact design offers safety together with reduced weight. Ideal for construction and maintenance applications.

ELECTRIC HOISTS

For vertical lifting with or without horizontal motion of the load. The motorized motion is dedicated for higher loads.

HAND CHAIN BLOCK WITH LOW HEADROOM BUILT IN TROLLEY

For vertical lifting and horizontal motion of the load. The low headroom conception of hoist and trolley combination extremely optimize the height of lift in reduced area.

JIB CRANES

Used in addition to lifting units (electric or manual hoist) to support horizontal or rotation motion of the load.

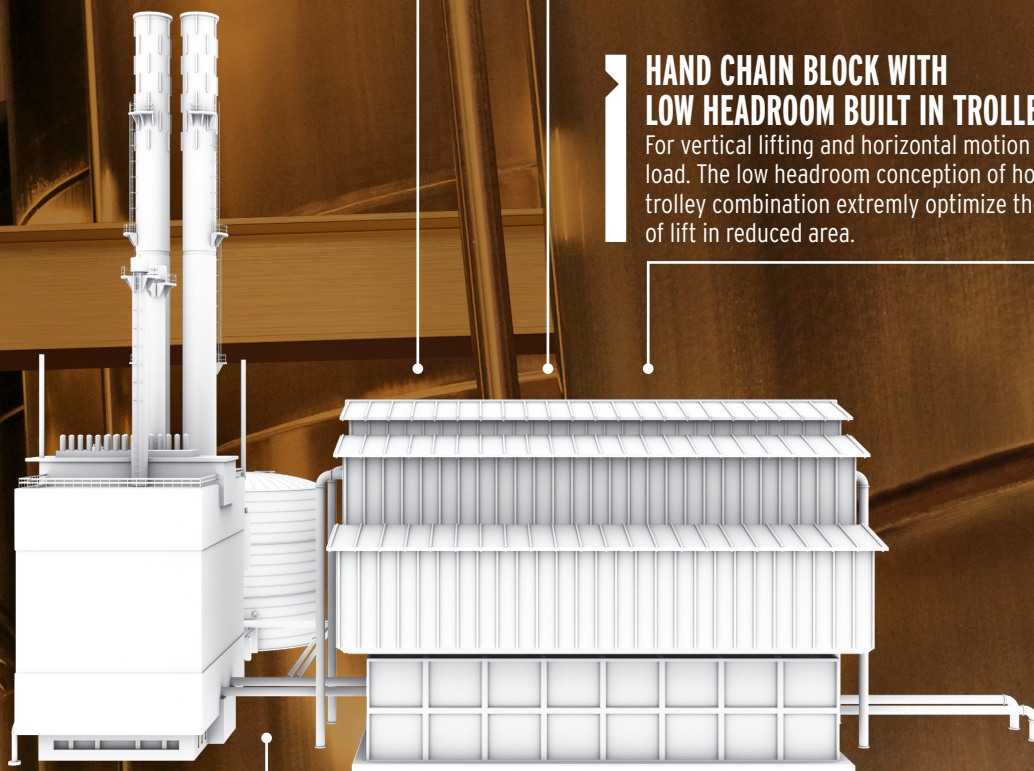

▶ ELECTRIC HOIST



EUROCHAIN VR[®] INOX

Electric chain hoist
for loads from
63 to 1,250 kg

► Technical characteristics

- › Stainless steel lifting chain.
- › New lifting nut concept with intermediate teeth for perfect chain drive.
- › Torque limiter.
- › Disk lifting brake.
- › 3 m standard lifting height.
- › Dual-speed lifting.
- › Safety electric end of run for up and down position.
- › IP55 lifting and travelling motor.
- › Thermal protection on lifting motor.
- › Tropic-proof protection (lifting and steering - 90 to 95 %).
- › Disconnectable command cable.
- › 2-buttons unit on fixed hoist or push steering carriage.
- › 4-buttons unit on hoist coupled to electric steering carriage.
- › Emergency stop button.
- › 400V/3Ph/50Hz or 415V/3Ph/50 Hz or 460V/3 Ph/60 Hz power supply.



► Options

- › Stainless steel lifting hook.
- › Biodegradable oil NSF H1 or dedicated for food (lifting and travelling gearbox, lifting chain). Lubricant clean and bubble for chains, sprockets and guides in the industry food. Oil synthetic anti-wear and extreme pressure, usable for incidental contact with the foodstuffs following the FDA requirements (certificates available on request).
- › Stainless steel load wheel on trolley hoist and accessory white finish Paint.
- › Level of protection increased : ATEX Zone 1, EEx.
- › Level of protection increased: ATEX Zone 22.
- › IP66 protection.
- › Variable speed lifting.
- › Extreme operating Temperatures: (-40 °C to +70 °C).
- › Wall control panel instead of the pendant.
- › Remote radio control.
- › Manual or electric trolley.



EUROLIFT BH[®]

Electric belt hoist for load from
250 to 5,000 kg



EUROLIFT BH[®]



The EUROLIFT BH electric belt hoist meets your needs for hoisting power with the strictest levels of cleanliness. The EUROLIFT BH is a hoist complying with EC European standards, offering you the lifting power and robustness of a product designed for industrial duty combined with 100% clean operation to meet your most stringent requirements with regard to hygiene, handling of foodstuffs and chemical products and "white room" conditions,...

► Technical characteristics

- › Anticorrosion product with high strength rot-proof belt.
- › Exceptionally little loss of headroom, enabling the EUROLIFT BH to adapt to all your installation configurations.
- › Lift motor with two mechanically variable speeds and two speed travel movement motor (complying with standard EC 34.1/IEC 34.2, IP 55 protection and insulation F) combined with perfectly sealed reduction gearing enabling your loads to be shifted silently with great precision.
- › A high security belt guide, electric hoisting limit switch and electrical load limiter as standard equipment, ensuring you, as user, maximum safety in every situation.
- › Variable speed travel motor for precise positioning of loads.
- › An option of this lifting unit offers greater protection with stainless steel or galvanised elements and an EX spark proof and/or explosion proof version (ATEX standard) is also available.

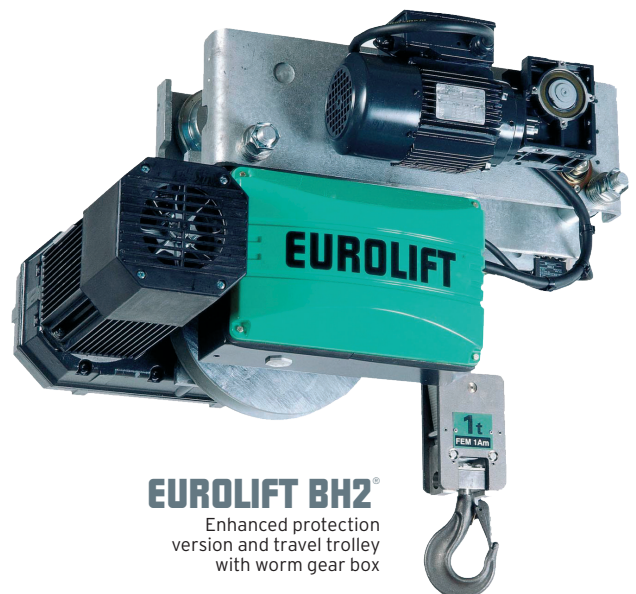

EUROLIFT BH2[®]
Enhanced protection
version and travel trolley
with worm gear box



EUROLIFT product code	Load capacity according FEM group (kg)			Reeving	Height of lift (m)	Lifting speed (m/min)	
	1 Bm	1 Am	2 m			1 speed	2 speeds
BH1	250	125	63	2	6	6,9	6,9/2,3
BH1	375	250	125	3	4	4,6	4,6/1,5
BH1	500	375	250	4	3	3,4	3,5/1,1
BH1	375	250	125	2	6	6,9	6,9/2,3
BH1	500	375	250	3	4	4,6	4,6/1,5
BH1	-	500	375	4	3	3,5	3,5/1,1
BH2	500	-	-	2	9	-	6 2/33
BH2	800	630	500	3	6	-	6 1/2
BH2	1000	800	630	2	9	-	6 1/4
BH2	1600	1250	1000	3	6	-	6 1/2
BH2	2000	1600	1250	4	4,5	-	6 1/4
BH2	3200	-	-	NC	NC	NC	NC
BH2	4000	-	-	NC	NC	NC	NC
BH2	5000	-	-	NC	NC	NC	NC



MANUAL HOISTS



500 kg



ZHR[®]

Hand chain block for loads from 500 to 20,000 kg

► Technical characteristics

- › Overload limiter is standard equipment.
- › Four-bearing lifting mechanism.
- › Offshore high-resistance RAL 7021 powder coating, 220 µ thick.
- › Machined chain sprocket and gears provide smoother, more efficient operation.
- › 3 meters standard lift. Hand chain is 0.5 meters less than lift chain. Non-standard lifts available.
- › High strength grade 80 alloy steel load chain with corrosion-resistant galvanized (complies with standard EN 818, safety factor 4). Made in Europe.
- › Galvanized hand chain made in Europe.
- › ZHR's compact design offers safety together with reduced weight. Ideal for construction and maintenance applications.
- › Steel casing solidly protects chain sprocket, gearcase and handwheel cover.
- › Upper and lower alloy steel ISO hooks with safety latches.
- › Weston-type load brakes.
- › Delivered with CE certificate, and hook and chain certificate.

► Options

A wide range of options is available for this hand chain block :

- › ZHR with stainless steel load and hand chain.
- › Chain bag.
- › ZHR HPN with normal headroom.
- › ZHR HPR with short headroom trolley.



Load	A	B	Øa1	a2	H4 min	Chain	Number of falls	Pulling force (kg)	Net weight (kg)
500 kg	148	132	35	23	345	5 x 15	1	35	11
1000 kg	172	151	40	27	376	6 x 18	1	25	12,5
1500 kg	196	173	45	33	442	7,1 x 21	1	35	17,8
2000 kg	210	175	50	35	470	8 x 24	1	35	19,5
3000 kg	255	205	55	39	548	10 x 28	1	40	35
5000 kg	280	189	65	45	688	9 x 27	2	36	41,3
7500 kg	433	189	47	67	688	9 x 27	3	38	62
10000 kg	463	189	75	57	765	9 x 27	4	38	78,5
12500 kg	430	220	75	54	835	9 x 27	5	38,4	110
16000 kg	718	200	95	71	900	9 x 27	6	38,7	135
20000 kg	840	200	106	85	950	9 x 27	8	38,7	192

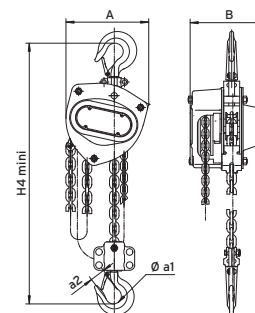

ZHR 1 fall

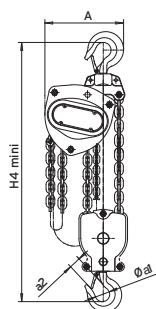

ZHR 2 fall

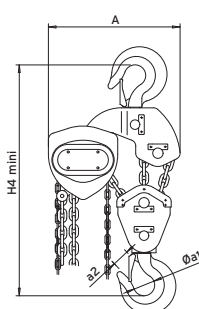

ZHR 3 fall

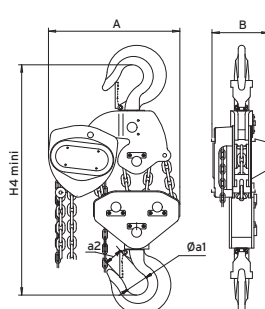

ZHR 4 fall

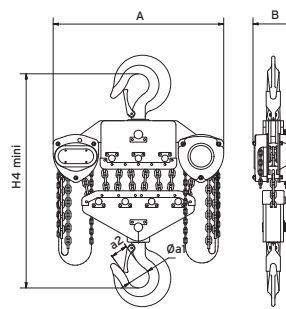

ZHR 5, 6 and 8 fall



ZHR-HPR[®]

Low headroom version
manual travelling trolley
hoist for loads from
500 to 20,000 kg

Especially designed for use in areas where optimal use of short headroom is essential.

► Technical characteristics

- > Characteristics of the hand chain block : see ZHR page 9.
- > Controlled via handwheel and chain.
- > Easy to adjust for different flange widths up to 305 mm.
- > Trolley body made of high-resistance steel.
- > Side plates finished with RAL 7021 dark gray coating, 70 µ thick.
- > Steel rollers machined for smooth movement.
- > Rollers compatible with all types of I and H beams.
- > Wheel ball bearings are moisture-tight and maintenance free.
- > Galvanized hand chain.
- > Fall-prevention brackets and rubber stops.
- > Loads up to 20 tons.
- > Serial number inscribed on chassis.

► Options

- > Ex version with ATEX Marking.
- > Stainless steel lift and hand chains.
- > Chain bag.

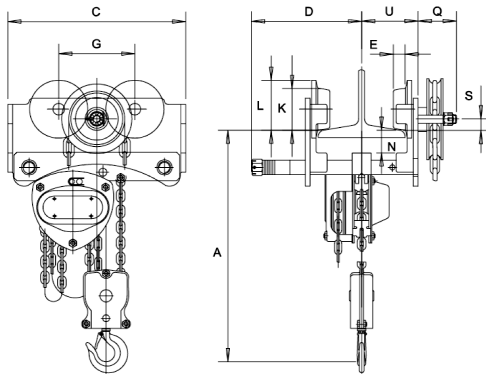

Dimensions in mm

Load	Dimensions in mm											Num. of falls	Range	Weight without chain (kg)	Additional weight per m of lifting height (kg)	Pulling force (N)
	A	C	D	E	G	K	L	N	Q	S	U					
500 kg	299	258	119	17	100	55	67	29	57	9	95	1	50-203	19	1.6	240
1000 kg	331	292	150	18	125	68	82	37	57	18	125	1	64-305	37	2.1	265
1500 kg	383	319	156	20	130	74	88	38	57	18	125	1	74-305	37	2.1	265
2000 kg	410	358	159	22	135	80	94	38	57	18	129	1	88-305	50	2.4	335
3000 kg	461	434	167	25	158	100	115	40	59	8	132	1	100-305	65	2.5	372
5000 kg	655	448	177	34	170	108	126	42	59	25	138	2	114-305	91	4.8	360
7500 kg	750	624	186	39	190	130	153	45	66	20	146	3	124-305	135	7.2	365
10000 kg	755	636	189	40	200	134	155	45	66	35	148	4	124-305	153	9.6	380
12500 kg	830	668	191	43	200	150	170	50	66	26	150	5	124-305	242	12	420
16000 kg	930	791	222	50	272	166	196	50	77	8	193	2 x 3	136-305	278	14.4	400
20000 kg	950	891	229	52	272	172	198	58	77	5	193	2 x 4	136-305	353	19.2	440

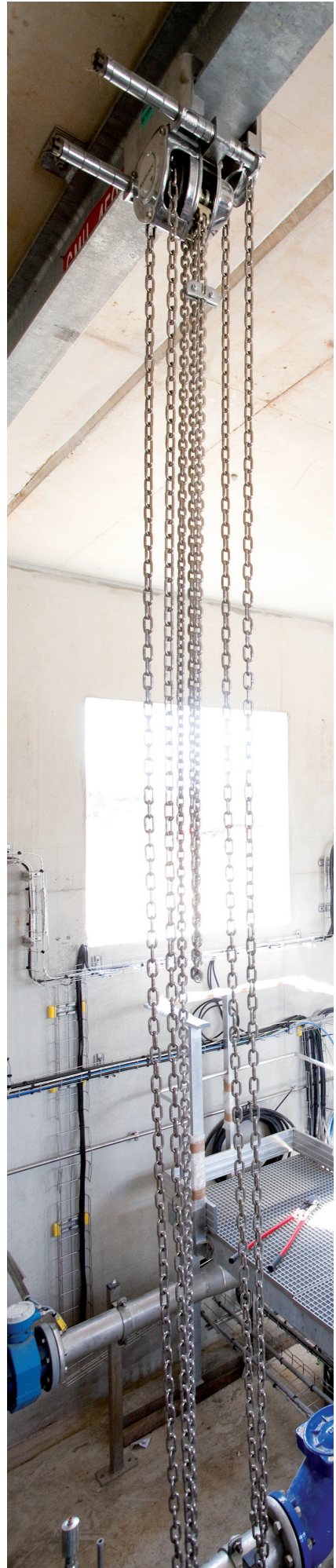

ZHV[®] INOX

Stainless steel hand chain block for loads from 500 to 1,000 kg



► Technical characteristics

- > ZHV totally stainless steel : body, hooks, lifting and hand chain chain.
- > Machined chain sprocket and gears provide smoother, more efficient operation.
- > 3 meters standard lift. Hand chain is 0.5 meters less than lift chain. Other length on request.
- > ZHV's compact design offers safety together with reduced weight. Ideal for construction and maintenance applications.
- > Stainless steel casing solidly protects chain sprocket, gearcase and handwheel cover.
- > Upper and lower hook ISO Stainless steel hooks with safety latch.
- > CE certificate.
- > Surface Treatment : Electrolytic Polishing.

► Options

- > CHV INOX trolley normal headroom (HPN).
- > Load limiter.

► Material list

- > Hand chain : SUS316.
- > Load chain : SUS316L.
- > Hook part and Sheave : SUS304.
- > Pin and Bush : SUS420J2.
- > Covers and Plates : SUS304.
- > Name Plate : SUS316.

ZHV[®]
500 kg

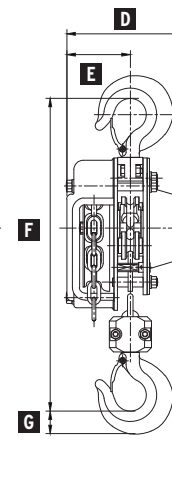
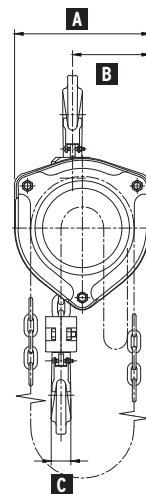
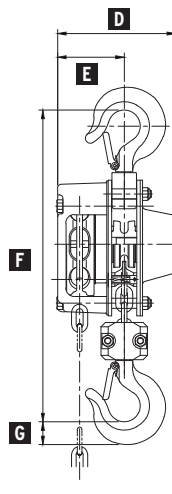
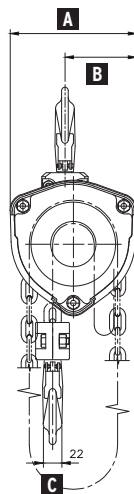

ZHV[®]
1000 kg

Load (kg)	Dimensions in mm							Height of lift std (m)	Hand chain length (m)	Lifting chain size (mm)	Num. of falls	Effort to place on chain to lift the load (kg)	Weight (kg)
	A	B	C	D	E	F	G						
500	150	85	22	143	81	330	25	2,5	2,0	Ø 6,3 x P 19,0	1	33	12,1
1000	193	110,5	28	165,8	91,8	400	32	2,5	2,0	Ø 7,9 x P 23,0	1	35	19,7

CHZ[®] INOX

Stainless steel trolley for loads from 500 to 1,000 kg



► Technical characteristics

- > CHZ INOX trolley totally Stainless steel : End plate, suspension beam, load wheel.
- > The CHZ INOX trolley may be used with any type of manual lifting equipment fitted with a hook.
- > Push travel trolley.
- > Stainless steel load wheel made on machine center for smooth motion.
- > Stainless steel load wheel compatible with all type of profile I or H.
- > Bearing are dust protected and maintenance free.
- > Serial number on plate fixed on the frame.
- > CE certificate.
- > Surface Treatment : Electrolytic Polishing.

► Options

- > ZHV INOX hand chain block.
- > Setting of beam width.

► Material list

- > Plate and Toller : SUS304.
- > Bearing : SUS420.
- > Name Plate : SUS316.

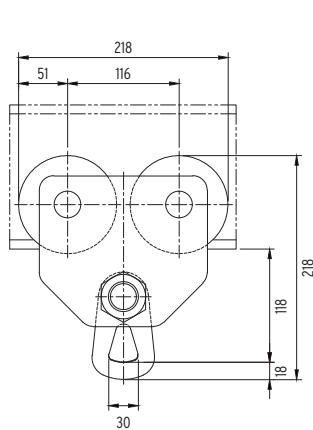

CHZ[®]
500 kg

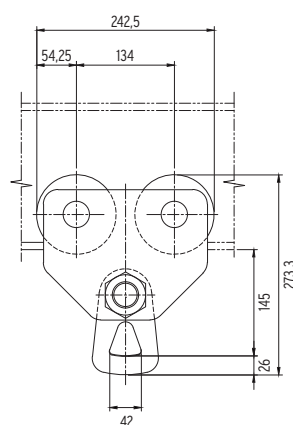
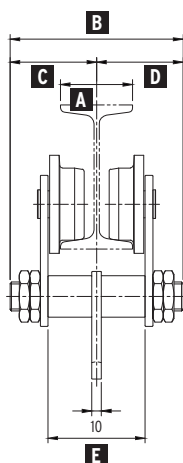

CHZ[®]
1000 kg

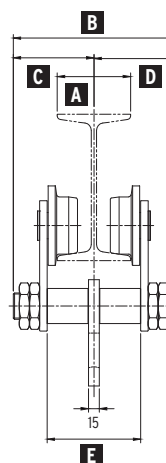

Load (kg)	Dimensions in mm					Min. distance from hook to traversing beam (mm)	Beam width (mm)	Min Radius (mm)	Weight (kg)
	A	B	C	D	E				
500	75	180	90	90	101	118	64	1200	10,5
	100	205	102,5	102,5	126	118	64	1200	10,5
	125	230	115	115	151	118	64	1200	10,5
1000	100	220	110	110	128	145	82	1300	15,8
	125	245	122,5	122,5	153	145	82	1300	15,8
	150	270	135	135	178	145	82	1300	15,8



JIB CRANES, GANTRIES AND LIFTING BEAMS





VFTAL[®]

Column mounted jib crane

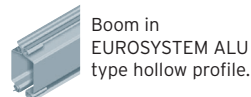

VATAL[®]

Wall mounted jib crane

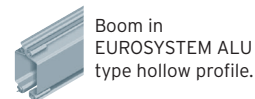

Beam of EUROSTYLE VATAL wall mounting and VFTAL column mounted jib crane are made out EUROSYSTEM ALU aluminium profile. This range of jib crane gives the ideal solution for work stations located near a wall or vertical structures. It can be used over a sector measuring 180° (VATAL) or 270° (VFTAL) with a radius between 2 and 8 meters. They are the complement you can't do without for rolling cranes, for the overall efficiency in a workshop. They make each production point independent and ultra-efficient.



VGPA[®]

Workshop gantries



The beam of these VERLINDE workshop gantries crane consists of a EUROSYSTEM hollow profile in aluminium. Delivered with a manual hoist-bearing EUROSYSTEM type trolley. These workshop gantries are mounted on caster wheels in white polyamid. The gantry can be moved under load.

Rupture safety factor : 5.
 The PAL line is manufactured to standard NFE 52210 and classed category FEM 5. No load bearing welds. Anti-rust treatment and RAL1028 glycerine paint finish. Standard equipment : bow shackles, reel hooks and safety latches.

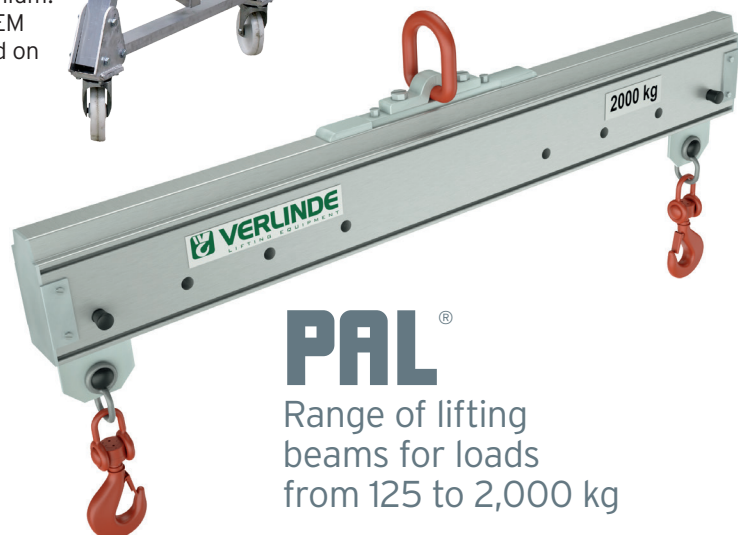

PAL[®]

Range of lifting beams for loads from 125 to 2,000 kg



EUROSYSTEM ALU



EUROSYSTEM ALU[®]

Aluminium hollow profile overhead handling system for loads from 60 to 2,000 kg

The Aluminium Eurosystem represents a new generation of hollow profile handling systems. This innovative solution presents the combined advantages of conventional steel and aluminium hollow profile.

► Technical characteristics

A graded range of 4 sizes of profile.
As for steel sections, the selection of the model will depend on the load capacity and the distance between the suspension points.

- > AL06, 6.5 kg/m, up to 320 kg.
- > AL08, 8 kg/m, up to 500 kg.
- > AL06, 10.6 kg/m, up to 2,000 kg.
- > AL06, 14.5 kg/m, up to 2,000 kg.

► Advantages of aluminium

- > **ERGONOMIC.** The lightness of the rails provides easy, effortless manipulation by the user even with heavy and unwieldy loads.
- > **PRECISE.** Precision is ensured by top quality manufacturing and smooth manoeuvring.
- > **ANTI -CORROSIVE TREATMENT.** The profile aluminium is anodized outside and inside.
- > **ECONOMICAL.** By the reduced volume and simplification of the bearing structures, by the rapidity of assembly.
- > **NEW TECHNOLOGY.** The profile was made possible by the latest cold extrusion engineering innovations and optimisation of structures.
- > **PRACTICAL.** The profile is compatible with all ITEM standardised accessories.
- > **LONG LIFE SPAN.** The remarkable resistance to wear is due to the anodizing treatment and to the roller material.
- > **SAFETY.** The profile is guaranteed weldless.
- > **NOISELESS.** The very low noise level of operation is due to the great smoothness of the rolling surface.



EUROSYSTEM ALU[®]

Aluminium hollow profile overhead handling system for loads from 60 to 2,000 kg

L'Eurosystem ALU in figures:

- > Materials: **6063-T6** according to EN-AW standard
- > 20 micron anodisation: **A6C0**
- > Extrusion tolerance of beams according to standard: **EN 12020**
- > Complies with applicable regulations according to standard: **FEM 9.771**

2

4 sizes of beam.

- > AL06, 6.5 kg/m, up to 320 kg.
- > AL08, 8 kg/m, up to 500 kg.
- > AL10, 10.6 kg/m, up to 2,000 kg.
- > AL14, 14.5 kg/m, up to 2,000 kg.

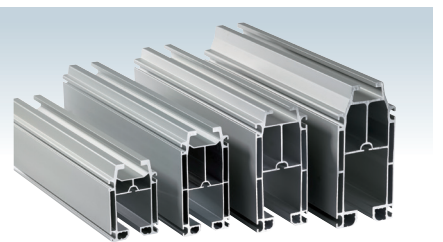

4

3

1

1

Locking plates.

They can be dismantled, they act as a buffer, dust protection and they complete the attractiveness of the installation.

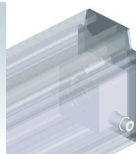

3

Joining of rails.

A perfect cut, pin pointer, 16 point locking system which is easy to implement: one of the features that make the difference.

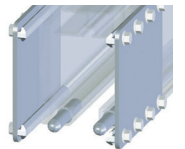

4

Suspensions.

It means that the whole handling system can be fixed to a lifting structure. Several suspension types are available depending on the type of beam used and the type of the host structure.

6

5

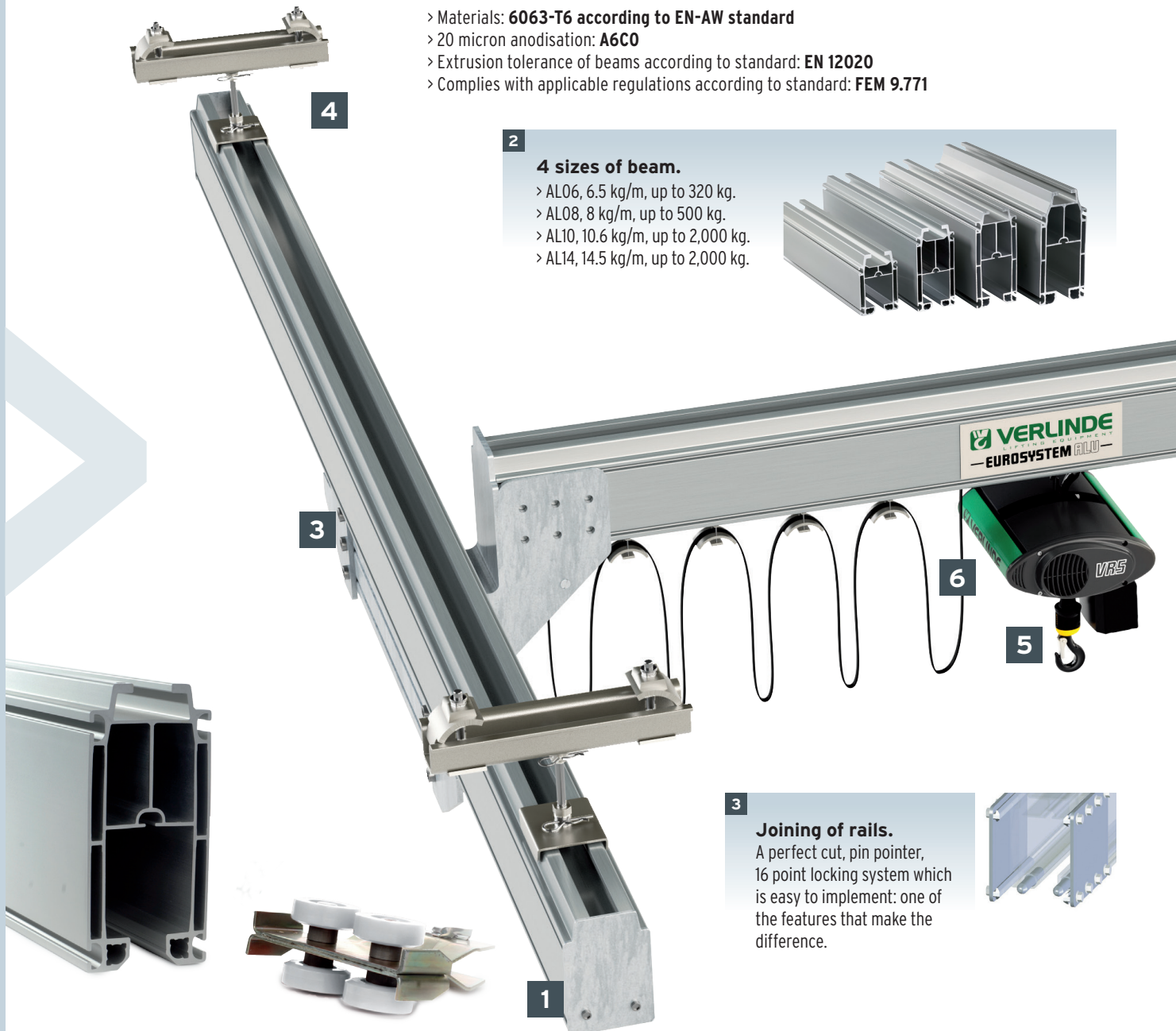

VERLINDE
THE GROUP
EUROSYSTEM ALU

VRS

6

Direction and transfer trolley.

Synthetic rollers on ball bearings. High security suspension by ball thrust bearing Double buffer.

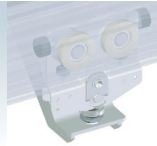

2



5

EUROCHAIN VR inox hoists with a variety of load capacities and lifting speeds. These hoists can be equipped with either a manual or an electric trolleys for horizontal movement.

- > Load capacity from 63 à 2,000 kg.
- > Lifting height from 3 meters (standard) and up to 30 m.
- > Two lifting speeds.
- > A number of optional features are available for these hoists (remote control system, hook version and stainless steel chain, etc).



Lifting motion could be assume by Hand chain block ZHV INOX.

ZHV's compact design offers safety together with reduced weight. Ideal for construction and maintenance applications. Stainless steel casing solidly protects chain sprocket, gearcase and handwheel cover.



Better workstation ergonomics and increased productivity.

Compared with steel rails, when manually moving loads, the movement coefficient of the trolley rollers is greatly reduced in order to minimise operator effort.

Reduced cost of supporting structures.

- > 2 times lighter than its steel equivalent.
- > Easy to install and use.
- > Economical for lifting structures.

