

SPARE PARTS - SR25

To avoid errors, when ordering please specify:

- Complete type of hoist
- Date of manufacture and serial number
- Spare part code
- Spare part designation
- Additional information



1) FRAME

- 1.1) Rotary hook
- 1.2) Fixed hook
- 1.3) Suspension eye

2) CHAIN GUIDE - 1 FALL

- 2.1) Standard limit switch - Standard hook
- 2.2) Standard limit switch - Automatic hook
- 2.3) Gear limit switch - Standard hook
- 2.4) Gear limit switch - Automatic hook

3) CHAIN GUIDE - 2 FALLS

- 3.1) Standard limit switch - Standard hook
- 3.2) Standard limit switch - Automatic hook
- 3.3) Gear limit switch - Standard hook
- 3.4) Gear limit switch - Automatic hook

4) GEAR

- 4.1) Single brake
- 4.2) Double brakes

5) MOTOR

6) ELECTRICAL PARTS

- 6.1) Version A
- 6.2) Version B

1) Frame

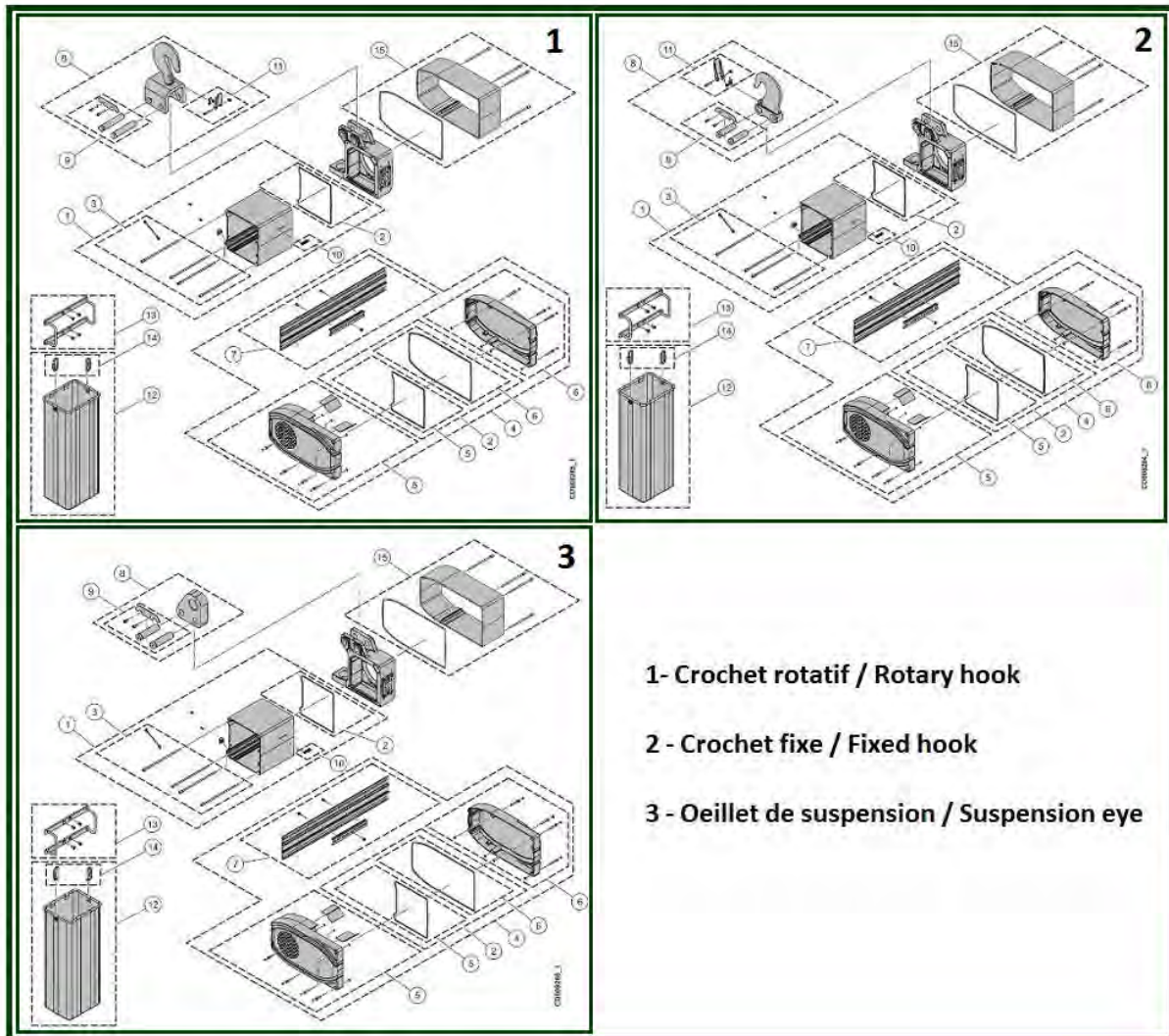

1.1) Rotary hook

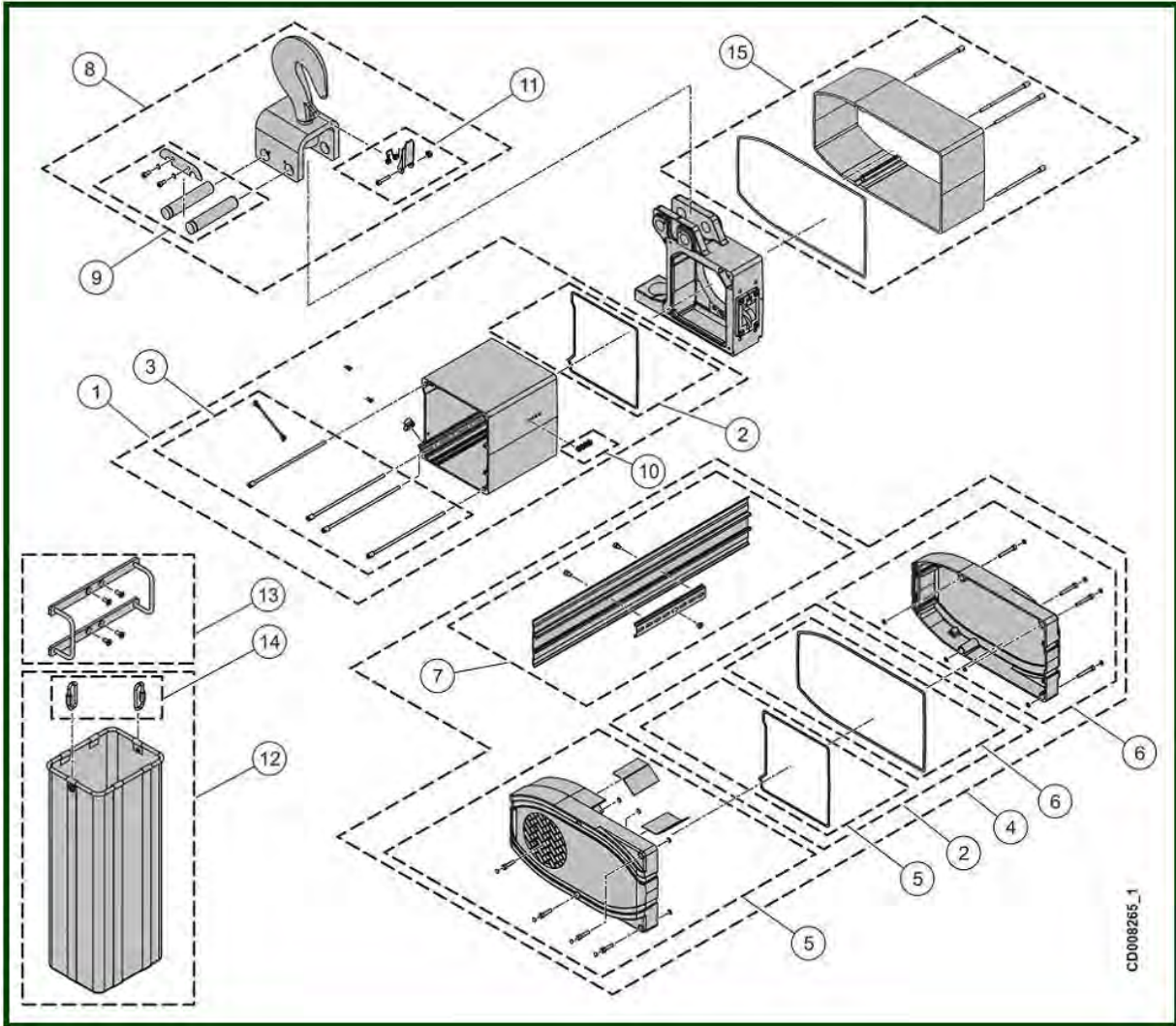

item	reference	description	observation	Quantity
1	VT0006575	Electrical housing	Limiteur de course standard / Standard limit switch	1
2	VT0006576	Sealings set		1
3	VT0006577	Screws set - M6L207		1
4	VT0008769	Complete cover set	Double freins / Double brakes	1
4	VT0008768	Complete cover set	Simple frein / Single brake	1
5	VT0008770	Cover set - Motor side		1
6	VT0008771	Cover set - Brake side		1
7	VT0008667	Cover set - Front side	Double freins / Double brakes	1
7	VT0008666	Cover set - Front side	Simple frein / Single brake	1
8	VT0008668	Rotating hook		1
9	VT0008669	Fixing set - Rotating hook		1
10	VT0006090	Set of 4 plugs	OPTION : Fin De Course à Cames / Gear Limit Switch	1
11	VT0005902	Safety latch	RSN08	1
12	VT0008665	Canvas chain bag set (+ 2 links)	20 m	1
12	VT0008772	Canvas chain bag set (+ 6 links)	50 m	1
13	VT0008663	Fixing set of chain bag		1
14	VT0008664	Quick link set	2 maillons / links	1
14	VT0008774	Quick link set	6 maillons / links	1
15	VT0008763	Housing		1

1.2) Fixed hook

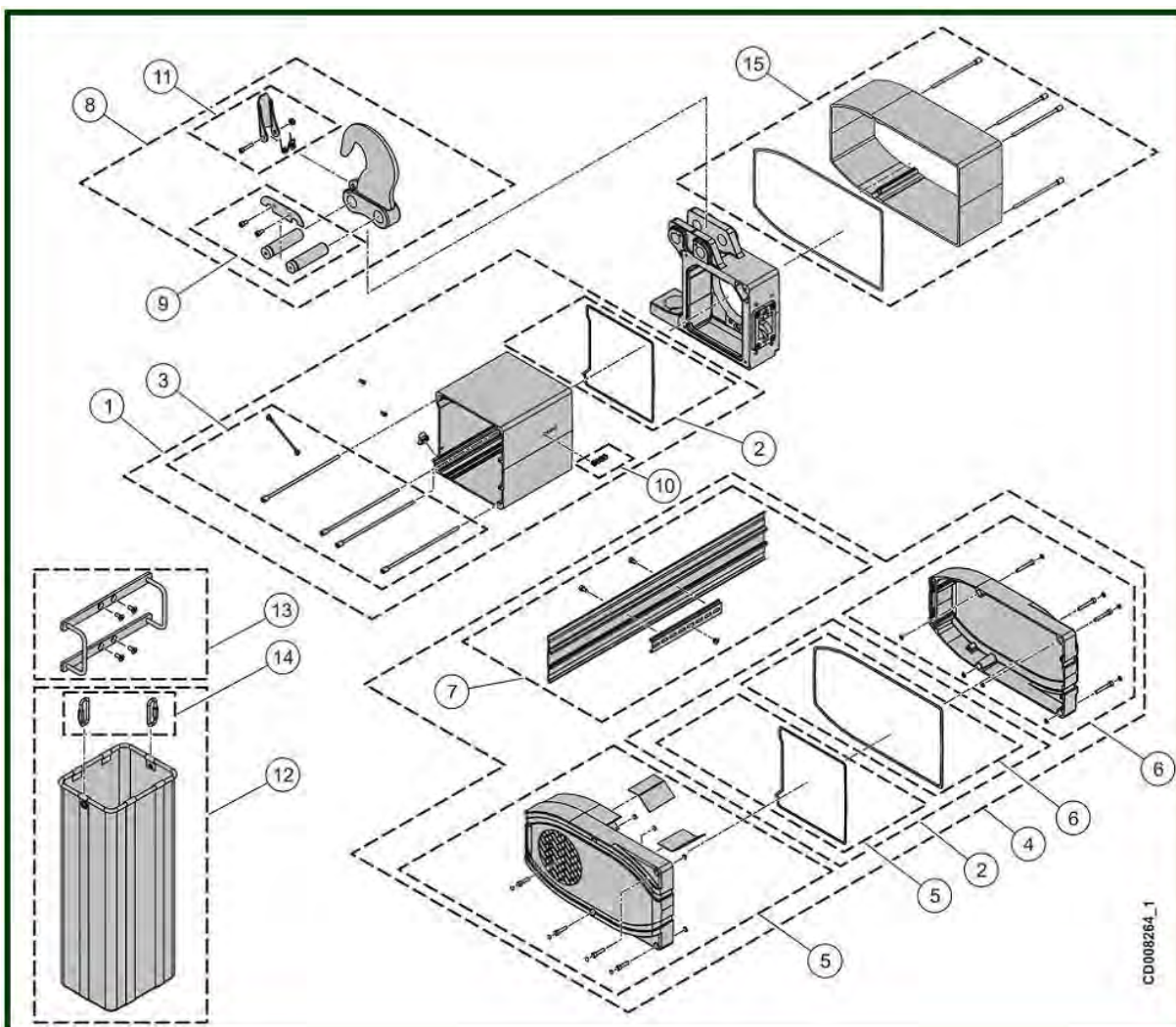

CD000264_1

item	reference	description	observation	Quantity
1	VT0006575	Electrical housing	Limiteur de course standard / Standard limit switch	1
2	VT0006576	Sealings set		1
3	VT0006577	Screws set - M6L207		1
4	VT0008769	Complete cover set	Double freins / Double brakes	1
4	VT0008768	Complete cover set	Simple frein / Single brake	1
5	VT0008770	Cover set - Motor side		1
6	VT0008771	Cover set - Brake side		1
7	VT0008667	Cover set - Front side	Double freins / Double brakes	1
7	VT0008666	Cover set - Front side	Simple frein / Single brake	1
8	VT0006583	Suspension hook		1
9	VT0006584	Fixing set		1
10	VT0006090	Set of 4 plugs	OPTION : Fin De Course à Cames / Gear Limit Switch	1
11	VT0005902	Safety latch	RSN08	1
12	VT0008665	Canvas chain bag set (+ 2 links)	20 m	1
12	VT0008772	Canvas chain bag set (+ 6 links)	50 m	1
13	VT0008663	Fixing set of chain bag		1
14	VT0008664	Quick link set	2 maillons / links	1
14	VT0008774	Quick link set	6 maillons / links	1
15	VT0008763	Housing		1

1.3) Suspension eye

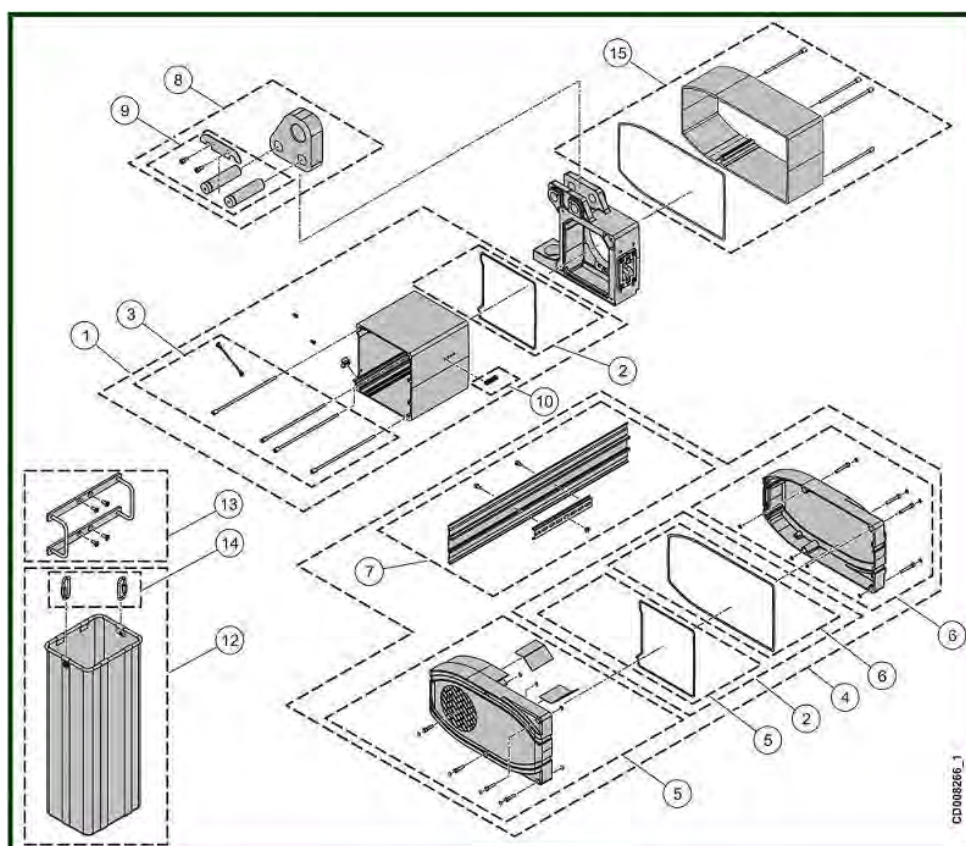

item	reference	description	observation	Quantity
1	VT0006575	Electrical housing	Limiteur de course standard / Standard limit switch	1
2	VT0006576	Sealings set		1
3	VT0006577	Screws set - M6L207		1
4	VT0008769	Complete cover set	Double freins / Double brakes	1
4	VT0008768	Complete cover set	Simple frein / Single brake	1
5	VT0008770	Cover set - Motor side		1
6	VT0008771	Cover set - Brake side		1
7	VT0008667	Cover set - Front side	Double freins / Double brakes	1
7	VT0008666	Cover set - Front side	Simple frein / Single brake	1
8	VT0006582	Suspension eye		1
9	VT0006584	Fixing set		1
10	VT0006090	Set of 4 plugs	OPTION : Fin De Course à Cames / Gear Limit Switch	1
12	VT0008665	Canvas chain bag set (+ 2 links)	20 m	1
12	VT0008772	Canvas chain bag set (+ 6 links)	50 m	1
13	VT0008663	Fixing set of chain bag		1
14	VT0008664	Quick link set	2 maillons / links	1
14	VT0008774	Quick link set	6 maillons / links	1
15	VT0008763	Housing		1

2) Chain guide - 1 fall

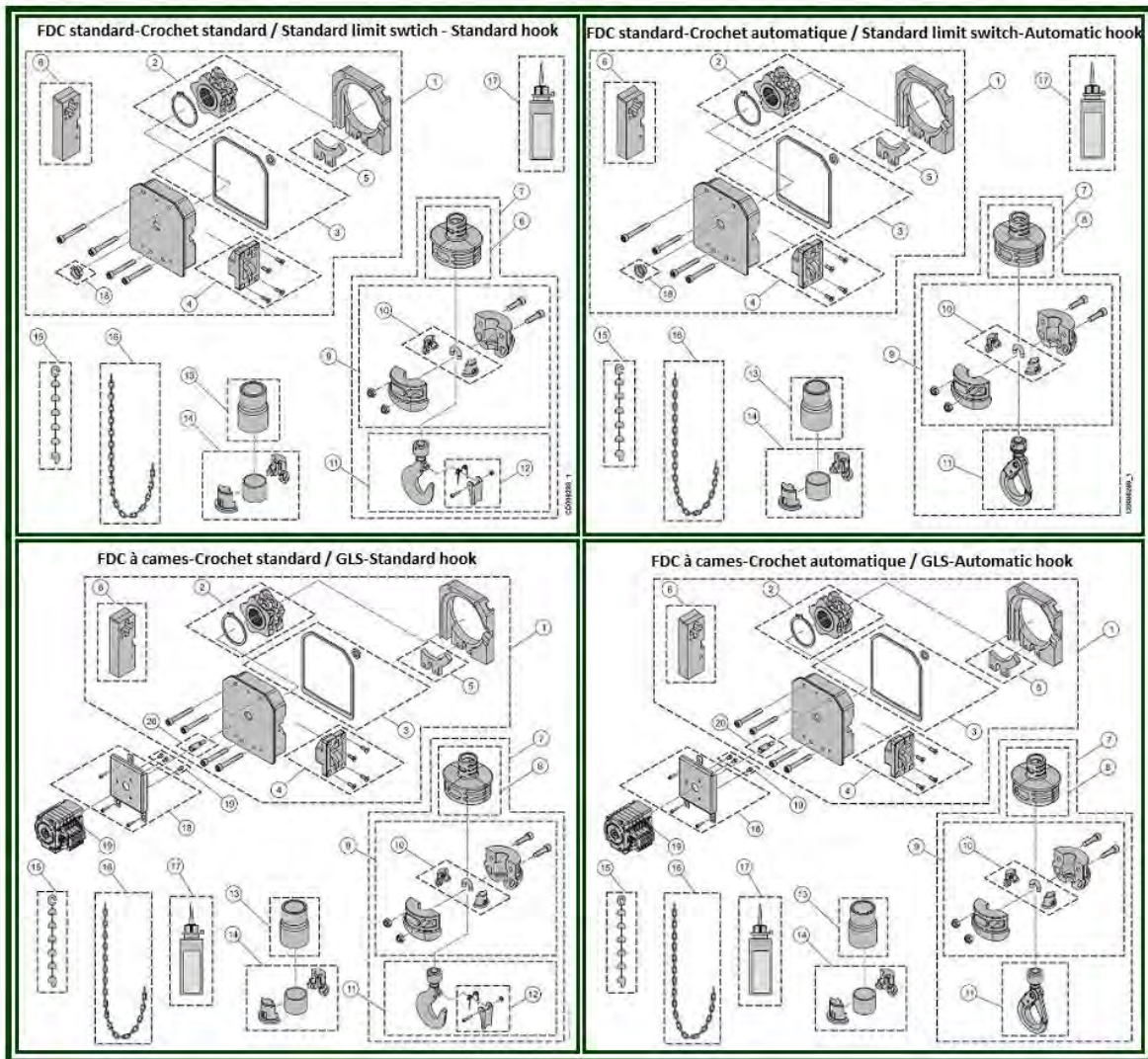

2.1) Standard limit switch - Standard hook

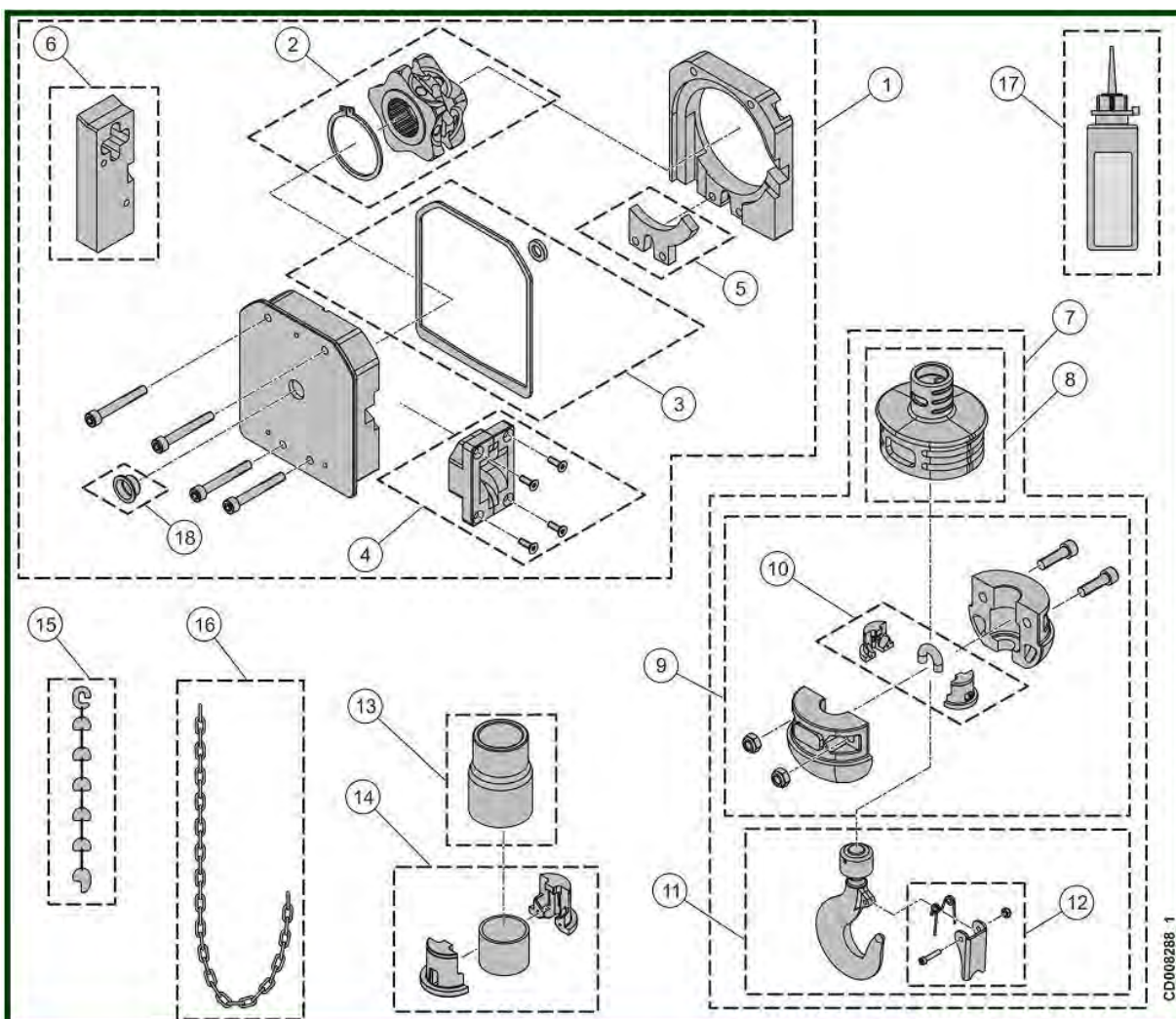

CD0008288_1

item	reference	description	observation	Quantity
1	VT0008740	Chain guide	Standard	1
2	VT0006587	Chain sprocket set		1
3	VT0008048	Sealings set		1
4	VT0008702	External chain flux		1
5	VT0008732	Plate	L87W67T10	1
6	VT0008737	Chain guide		1
7	VT0008688	Hook block	Crochet standard / Standard hook RSN08 - 1 brin / fall	1
8	VT0006592	Rubber chain stop	L120W108H95	1
9	VT0008690	Half casing set		1
10	VT0006594	Chain fixing set		1
11	VT0006374	Standard hook assembly	RSN08-7021 SR10 : 2 brins/falls SR25 : 1brin/fall	1
12	VT0005902	Safety latch	RSN08	1
13	VT0006601	Rubber chain stop		1
14	VT0006602	Chain stop		1
15	VT0006606	Chain fitting tool	Chaîne / Chain 11.3 x 31	1
16	VT0006605	Chain 11.3x31		1
17	VT0006025	Oil cane	CCGCCHCM-01	1
18	VT0008691	Cap	LDPE-12182	1

2.2) Standard limit switch - Automatic hook

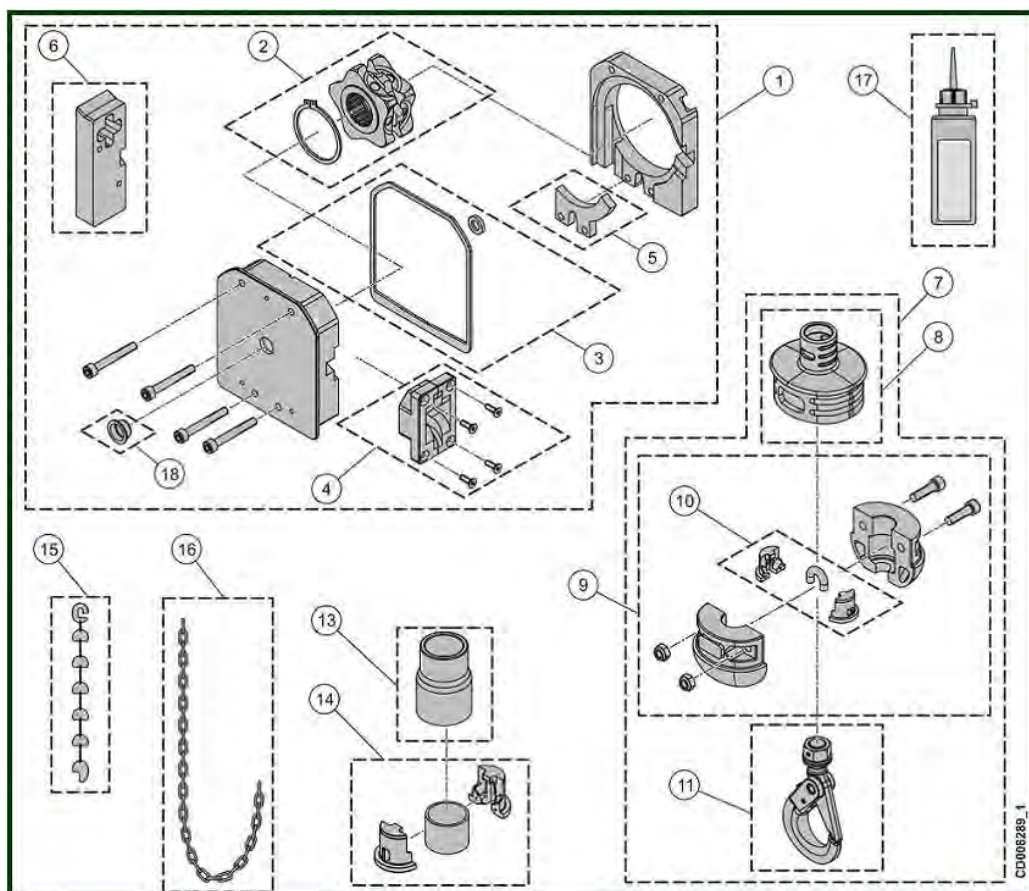

item	reference	description	observation	Quantity
1	VT0008740	Chain guide	Standard	1
2	VT0006587	Chain sprocket set		1
3	VT0008048	Sealings set		1
4	VT0008702	External chain flux		1
5	VT0008732	Plate	L87W67T10	1
6	VT0008737	Chain guide		1
7	VT0008689	Hook block	Crochet automatique / Automatic hook BKT-10-10 - 1 brin / fall	1
8	VT0006592	Rubber chain stop	L120W108H95	1
9	VT0008690	Half casing set		1
10	VT0006594	Chain fixing set		1
11	VT0006519	Automatic hook assembly	BKT-10-10	1
13	VT0006601	Rubber chain stop		1
14	VT0006602	Chain stop		1
15	VT0006606	Chain fitting tool	Chaîne / Chain 11.3 x 31	1
16	VT0006605	Chain 11.3x31		1
17	VT0006025	Oil cane	CCGCCHCM-01	1
18	VT0008691	Cap	LDPE-12182	1

2.3) Gear limit switch - Standard hook

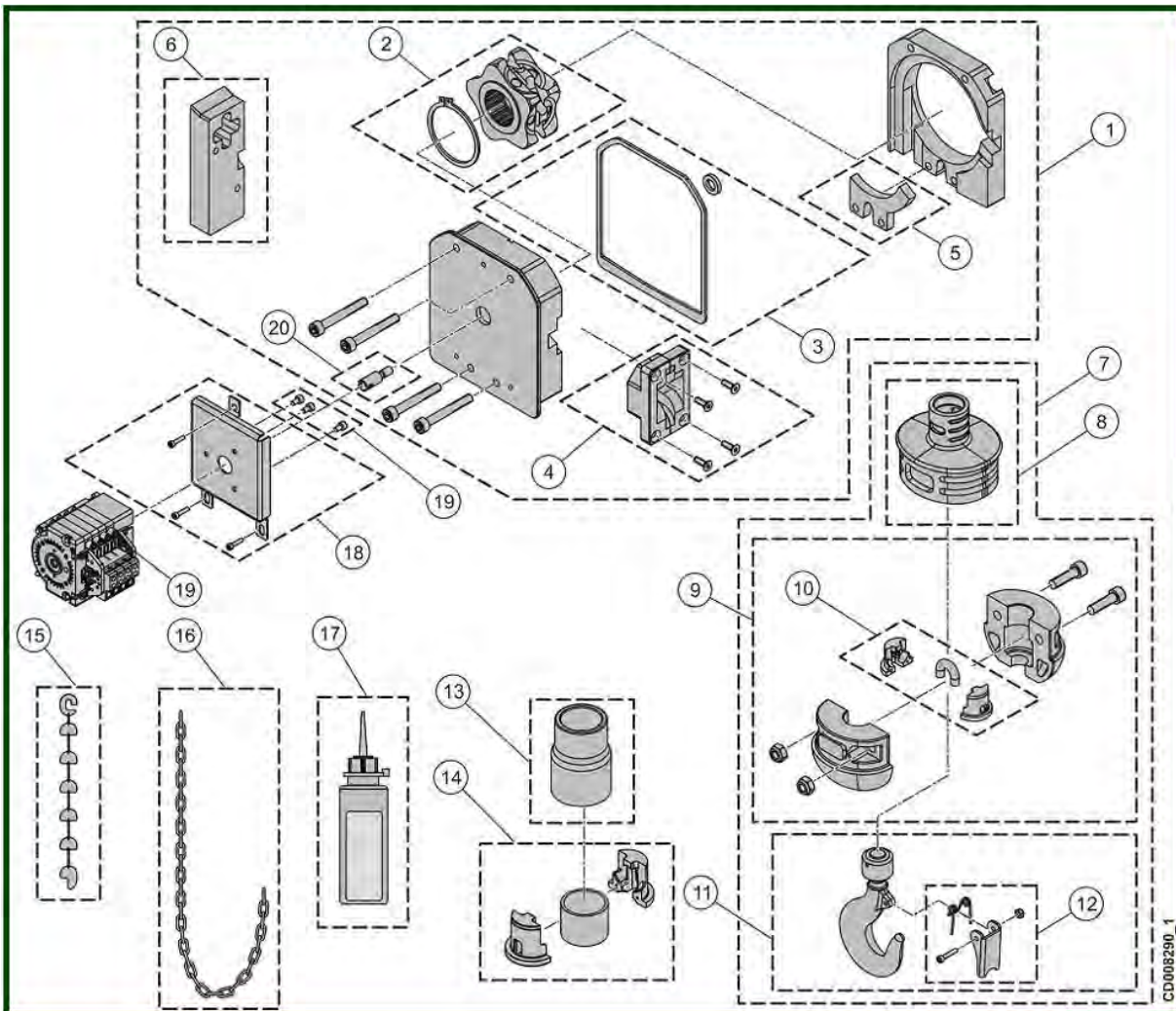

item	reference	description	observation	Quantity
1	VT0008741	Chain guide	Fin De Course à Cames / Gear Limit Switch	1
2	VT0006587	Chain sprocket set		1
3	VT0008048	Sealings set		1
4	VT0008702	External chain flux		1
5	VT0008732	Plate	L87W67T10	1
6	VT0008737	Chain guide		1
7	VT0008688	Hook block	Crochet standard / Standard hook RSN08 - 1 brin / fall	1
8	VT0006592	Rubber chain stop	L120W108H95	1
9	VT0008690	Half casing set		1
10	VT0006594	Chain fixing set		1
11	VT0006374	Standard hook assembly	RSN08-7021 SR10 : 2 brins/falls SR25 : 1brin/fall	1
12	VT0005902	Safety latch	RSN08	1
13	VT0006601	Rubber chain stop		1
14	VT0006602	Chain stop		1
15	VT0006606	Chain fitting tool	Chaîne / Chain 11.3 x 31	1
16	VT0006605	Chain 11.3x31		1
17	VT0006025	Oil cane	CCGCCHCM-01	1
18	VT0008047	Limit switch support		1

19	<u>VT0006113</u>	Geared limit switch - 2 steps with screw set	Hauteur de levée / Lift height : 20 m VR02=>20m : 1brin VR05=>25m : 1brin VR12=>36m : 1 brin - 18m : 2 brins VR16=>48m : 1 brin - 24m : 2 brins VR25=>56m : 1 brin - 28m : 2 brins	1
19	<u>VT0006252</u>	Geared limit switch - 4 steps with screw set	Hauteur de levée / Lift height : 20 m VR02=>20m : 1brin VR05=>25m : 1brin VR12=>36m : 1 brin - 18m : 2 brins VR16=>48m : 1 brin - 24m : 2 brins VR25=>56m : 1 brin - 28m : 2 brins	1
20	<u>VT0008767</u>	Coupling part	D15L41	1

2.4) Gear limit switch - Automatic hook

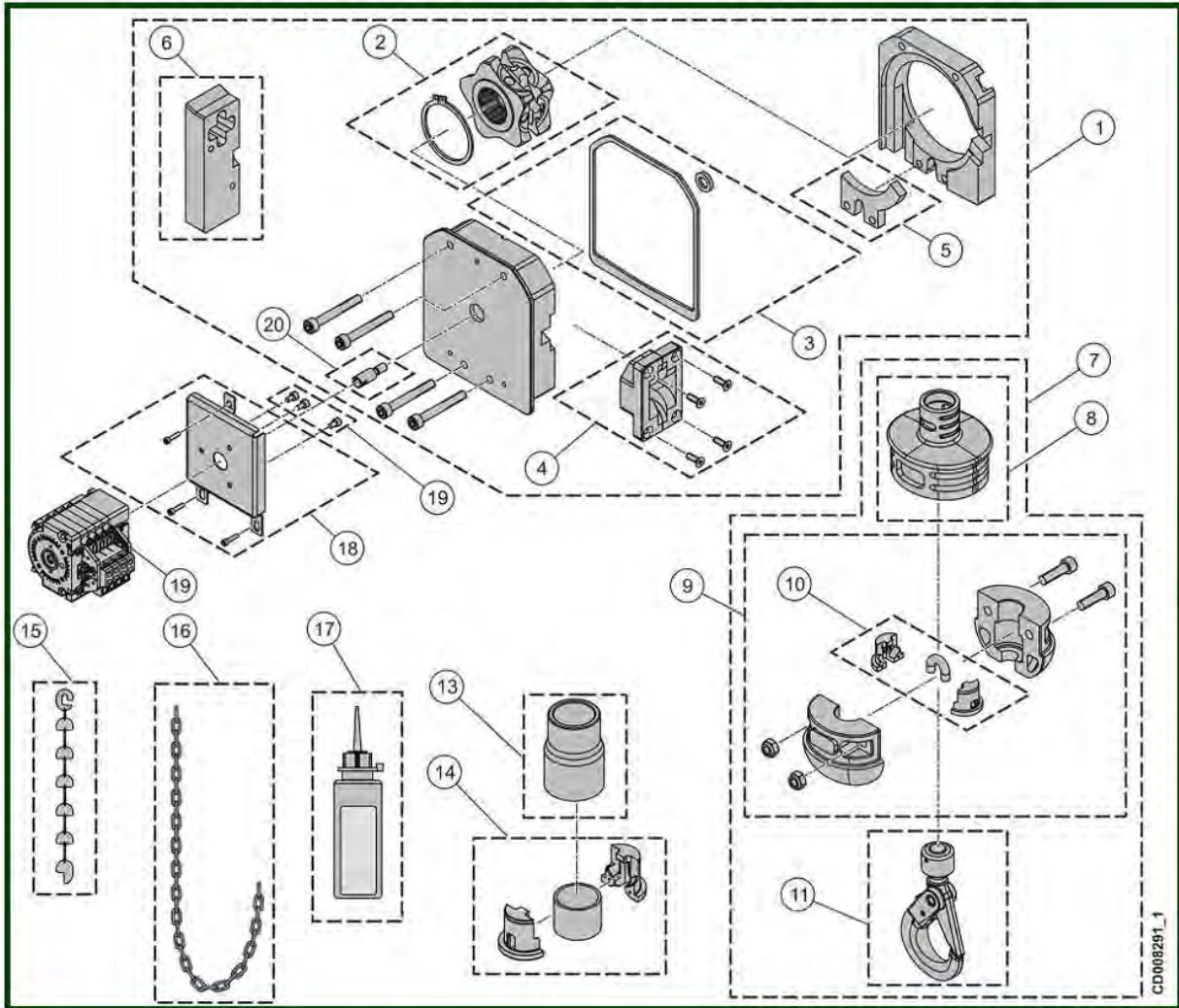

item	reference	description	observation	Quantity
1	VT0008741	Chain guide	Fin De Course à Cames / Gear Limit Switch	1
2	VT0006587	Chain sprocket set		1
3	VT0008048	Sealings set		1
4	VT0008702	External chain flux		1
5	VT0008732	Plate	L87W67T10	1
6	VT0008737	Chain guide		1
7	VT0008689	Hook block	Crochet automatique / Automatic hook BKT-10-10 - 1 brin / fall	1
8	VT0006592	Rubber chain stop	L120W108H95	1
9	VT0008690	Half casing set		1
10	VT0006594	Chain fixing set		1
11	VT0006519	Automatic hook assembly	BKT-10-10	1
13	VT0006601	Rubber chain stop		1
14	VT0006602	Chain stop		1
15	VT0006606	Chain fitting tool	Chaîne / Chain 11.3 x 31	1
16	VT0006605	Chain 11.3x31		1
17	VT0006025	Oil cane	CCGCCHCM-01	1
18	VT0008047	Limit switch support		1

19	<u>VT0006113</u>	Geared limit switch - 2 steps with screw set	Hauteur de levée / Lift height : 20 m VR02=>20m : 1brin VR05=>25m : 1brin VR12=>36m : 1 brin - 18m : 2 brins VR16=>48m : 1 brin - 24m : 2 brins VR25=>56m : 1 brin - 28m : 2 brins	1
19	<u>VT0006252</u>	Geared limit switch - 4 steps with screw set	Hauteur de levée / Lift height : 20 m VR02=>20m : 1brin VR05=>25m : 1brin VR12=>36m : 1 brin - 18m : 2 brins VR16=>48m : 1 brin - 24m : 2 brins VR25=>56m : 1 brin - 28m : 2 brins	1
20	<u>VT0008767</u>	Coupling part	D15L41	1

3) Chain guide - 2 falls

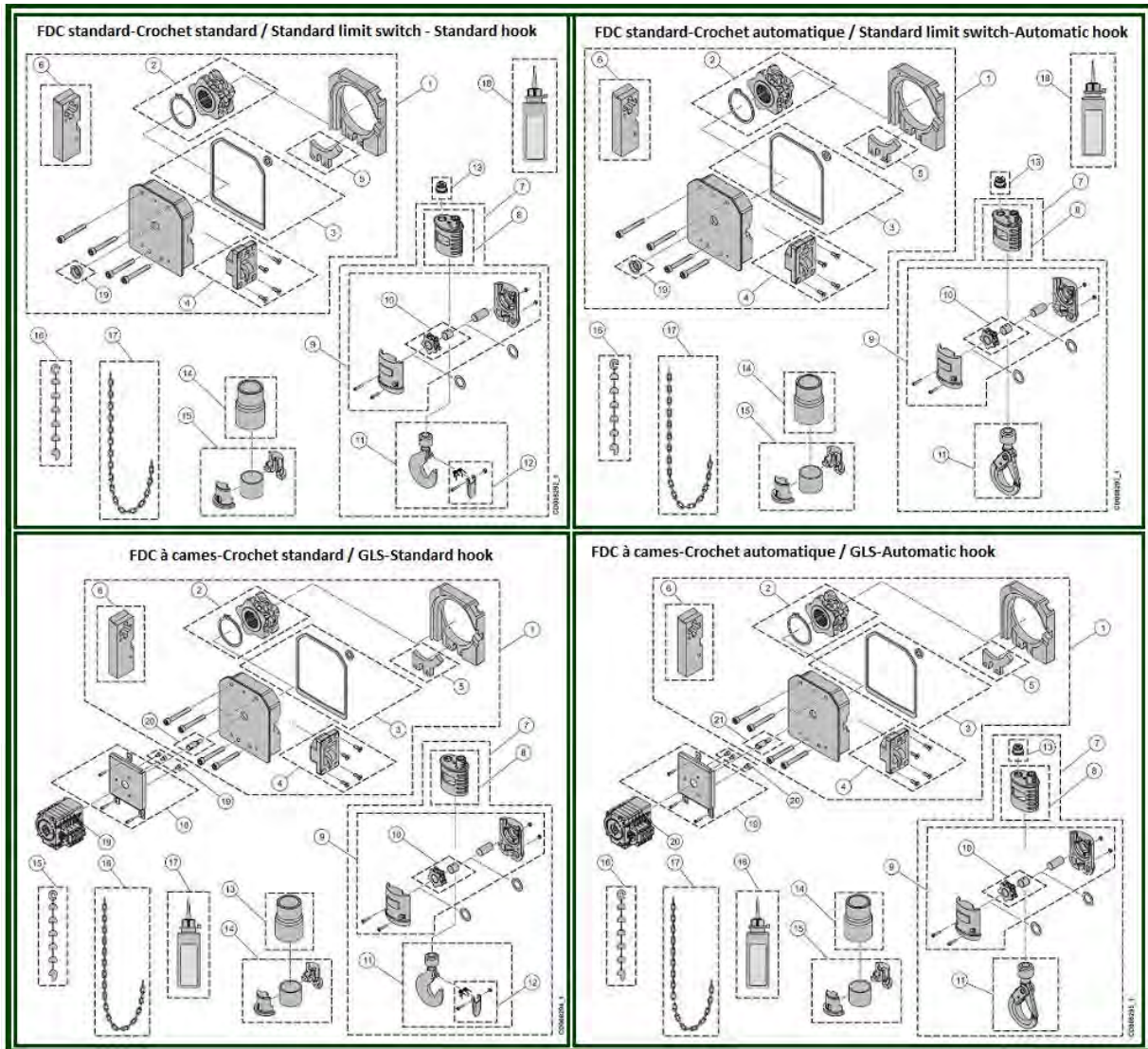

3.1) Standard limit switch - Standard hook

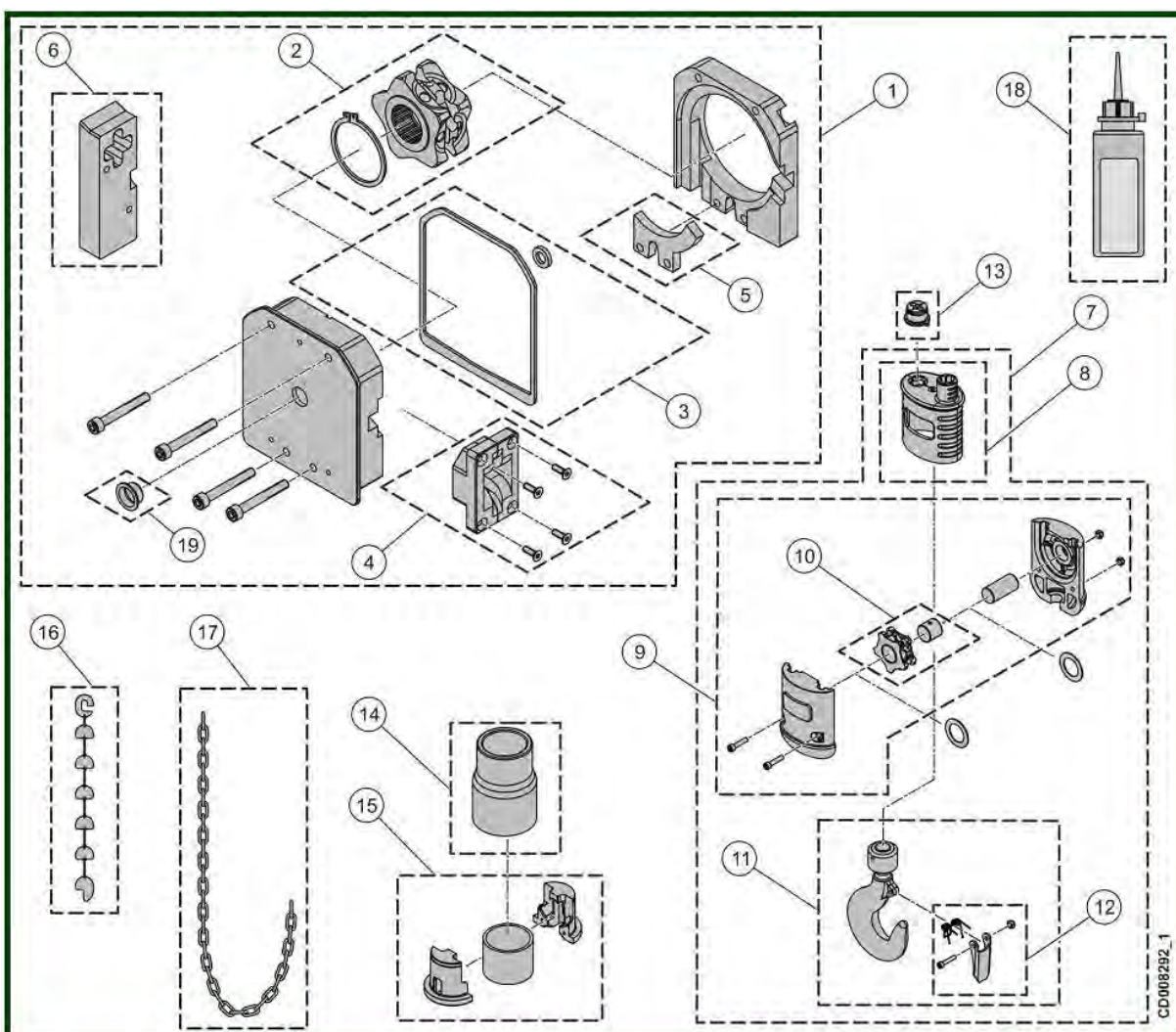

CD000292_1

item	reference	description	observation	Quantity
1	VT0008740	Chain guide	Standard	1
2	VT0006587	Chain sprocket set		1
3	VT0008048	Sealings set		1
4	VT0008702	External chain flux		1
5	VT0008732	Plate	L87W67T10	1
6	VT0008737	Chain guide		1
7	VT0008693	Bottom hook	RSN1,6	1
8	VT0006610	Buffer	L176W118H215	1
9	VT0008697	Hook bottle		1
10	VT0008695	Sprocket set		1
11	VT0008696	Hook assembly	RSN1,6-7021	1
12	VT0005902	Safety latch	RSN08	1
13	VT0006614	Fixing module	D60L40	1
14	VT0006601	Rubber chain stop		1
15	VT0006602	Chain stop		1
16	VT0006606	Chain fitting tool	Chaîne / Chain 11.3 x 31	1
17	VT0006605	Chain 11.3x31		1
18	VT0006025	Oil cane	CCGCCHCM-01	1
19	VT0008691	Cap	LDPE-12182	1

3.2) Standard limit switch - Automatic hook

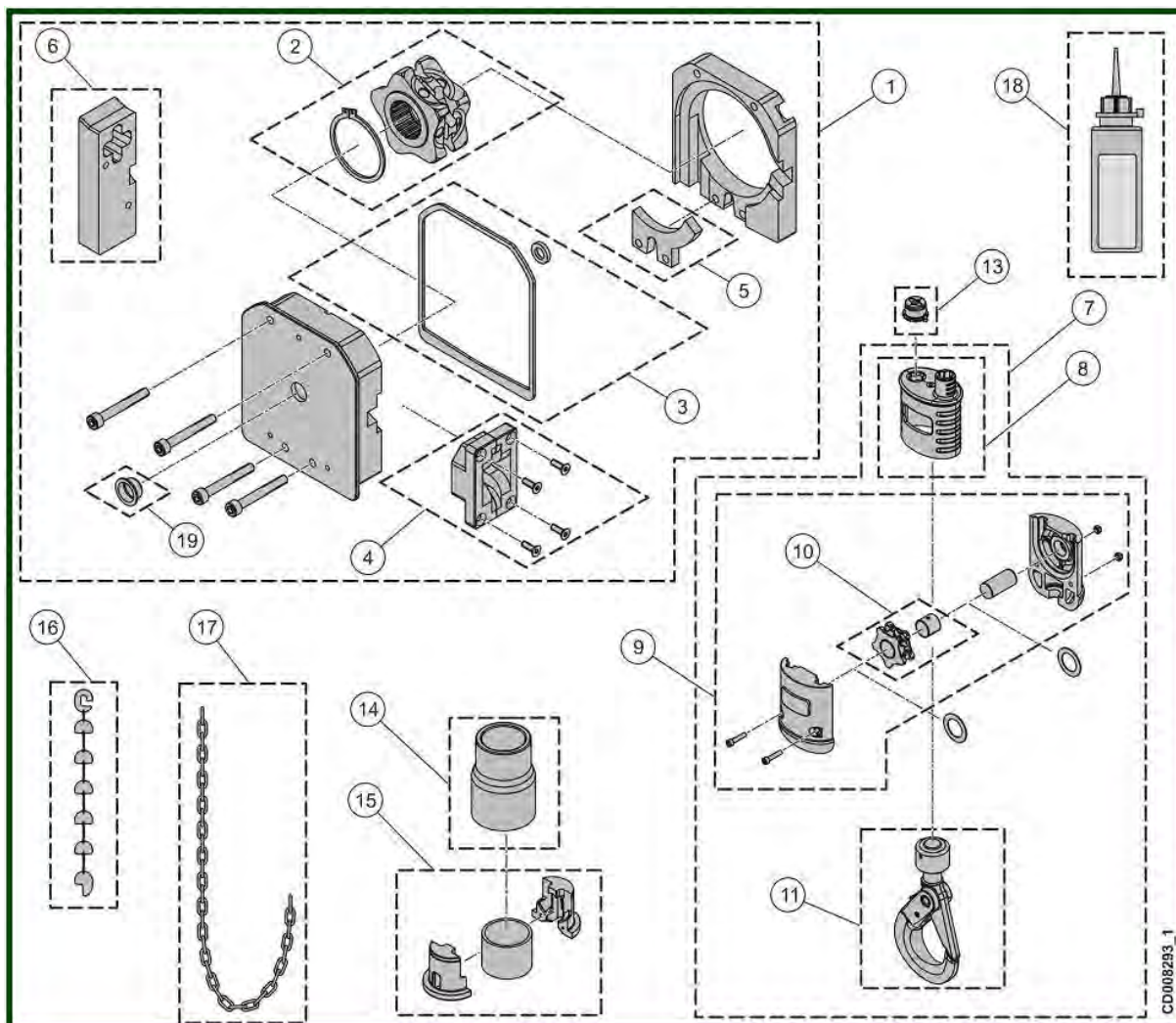

CD008293_1

item	reference	description	observation	Quantity
1	VT0008740	Chain guide	Standard	1
2	VT0006587	Chain sprocket set		1
3	VT0008048	Sealings set		1
4	VT0008702	External chain flux		1
5	VT0008732	Plate	L87W67T10	1
6	VT0008737	Chain guide		1
7	VT0008694	Complete hook block	BKT-13-10 Crochet automatique / Automatic hook	1
8	VT0006610	Buffer	L176W118H215	1
9	VT0008697	Hook bottle		1
10	VT0008695	Sprocket set		1
11	VT0007832	Automatic hook assembly	BKT-13-10	1
13	VT0006614	Fixing module	D60L40	1
14	VT0006601	Rubber chain stop		1
15	VT0006602	Chain stop		1
16	VT0006606	Chain fitting tool	Chaîne / Chain 11.3 x 31	1
17	VT0006605	Chain 11.3x31		1
18	VT0006025	Oil cane	CCGCCHCM-01	1
19	VT0008691	Cap	LDPE-12182	1

3.3) Gear limit switch - Standard hook

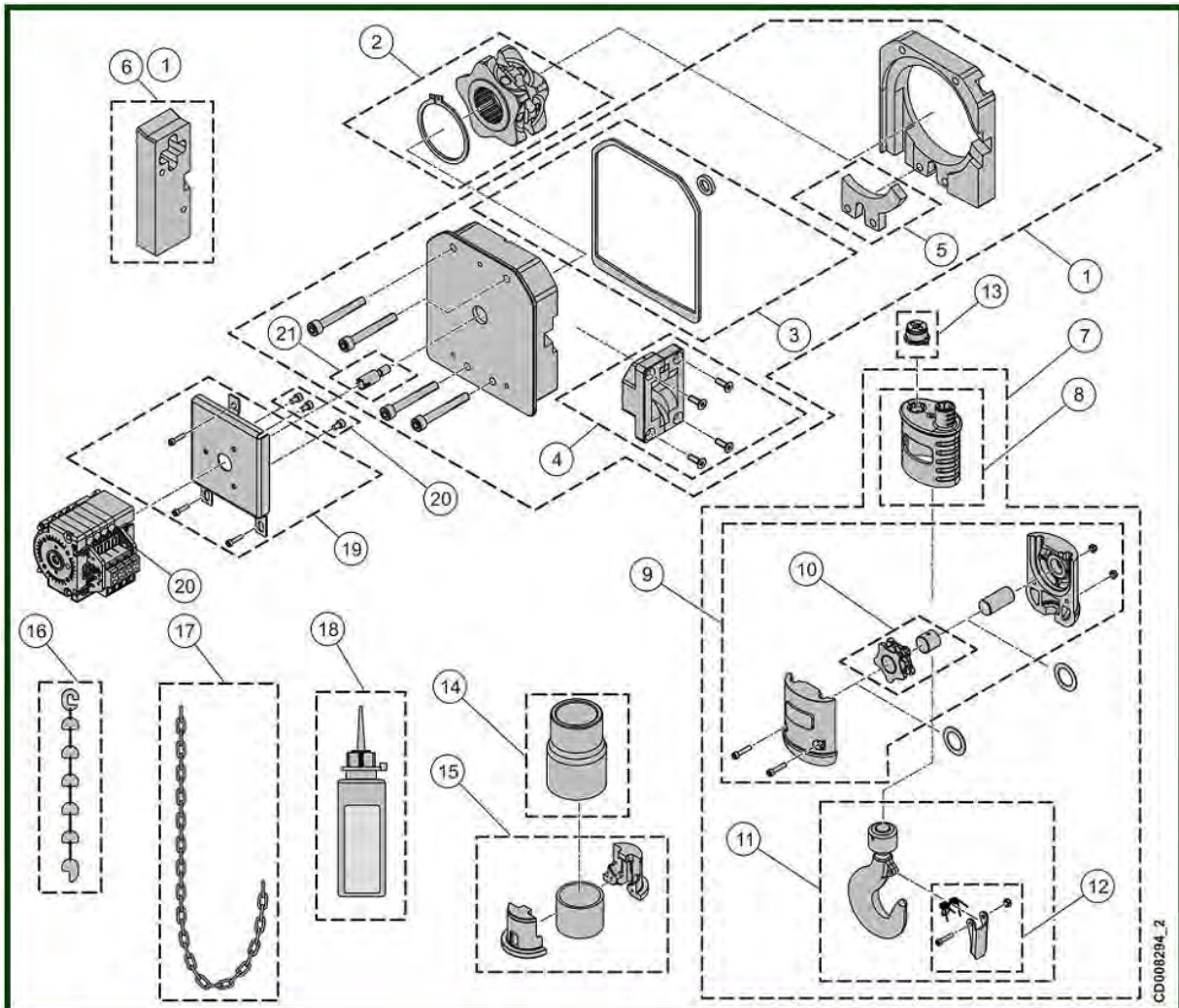

CD000294_2

item	reference	description	observation	Quantity
1	VT0008741	Chain guide	Fin De Course à Cames / Gear Limit Switch	1
2	VT0006587	Chain sprocket set		1
3	VT0008048	Sealings set		1
4	VT0008702	External chain flux		1
5	VT0008732	Plate	L87W67T10	1
6	VT0008737	Chain guide		1
7	VT0008693	Bottom hook	RSN1,6	1
8	VT0006610	Buffer	L176W118H215	1
9	VT0008697	Hook bottle		1
10	VT0008695	Sprocket set		1
11	VT0008696	Hook assembly	RSN1,6-7021	1
12	VT0005902	Safety latch	RSN08	1
13	VT0006614	Fixing module	D60L40	1
14	VT0006601	Rubber chain stop		1
15	VT0006602	Chain stop		1
16	VT0006606	Chain fitting tool	Chaîne / Chain 11.3 x 31	1
17	VT0006605	Chain 11.3x31		1
18	VT0006025	Oil cane	CCGCCHCM-01	1
19	VT0008047	Limit switch support		1

20	<u>VT0006113</u>	Geared limit switch - 2 steps with screw set	Hauteur de levée / Lift height : 20 m VR02=>20m : 1brin VR05=>25m : 1brin VR12=>36m : 1 brin - 18m : 2 brins VR16=>48m : 1 brin - 24m : 2 brins VR25=>56m : 1 brin - 28m : 2 brins	1
20	<u>VT0006252</u>	Geared limit switch - 4 steps with screw set	Hauteur de levée / Lift height : 20 m VR02=>20m : 1brin VR05=>25m : 1brin VR12=>36m : 1 brin - 18m : 2 brins VR16=>48m : 1 brin - 24m : 2 brins VR25=>56m : 1 brin - 28m : 2 brins	1
21	<u>VT0008767</u>	Coupling part	D15L41	1

3.4) Gear limit switch - Automatic hook

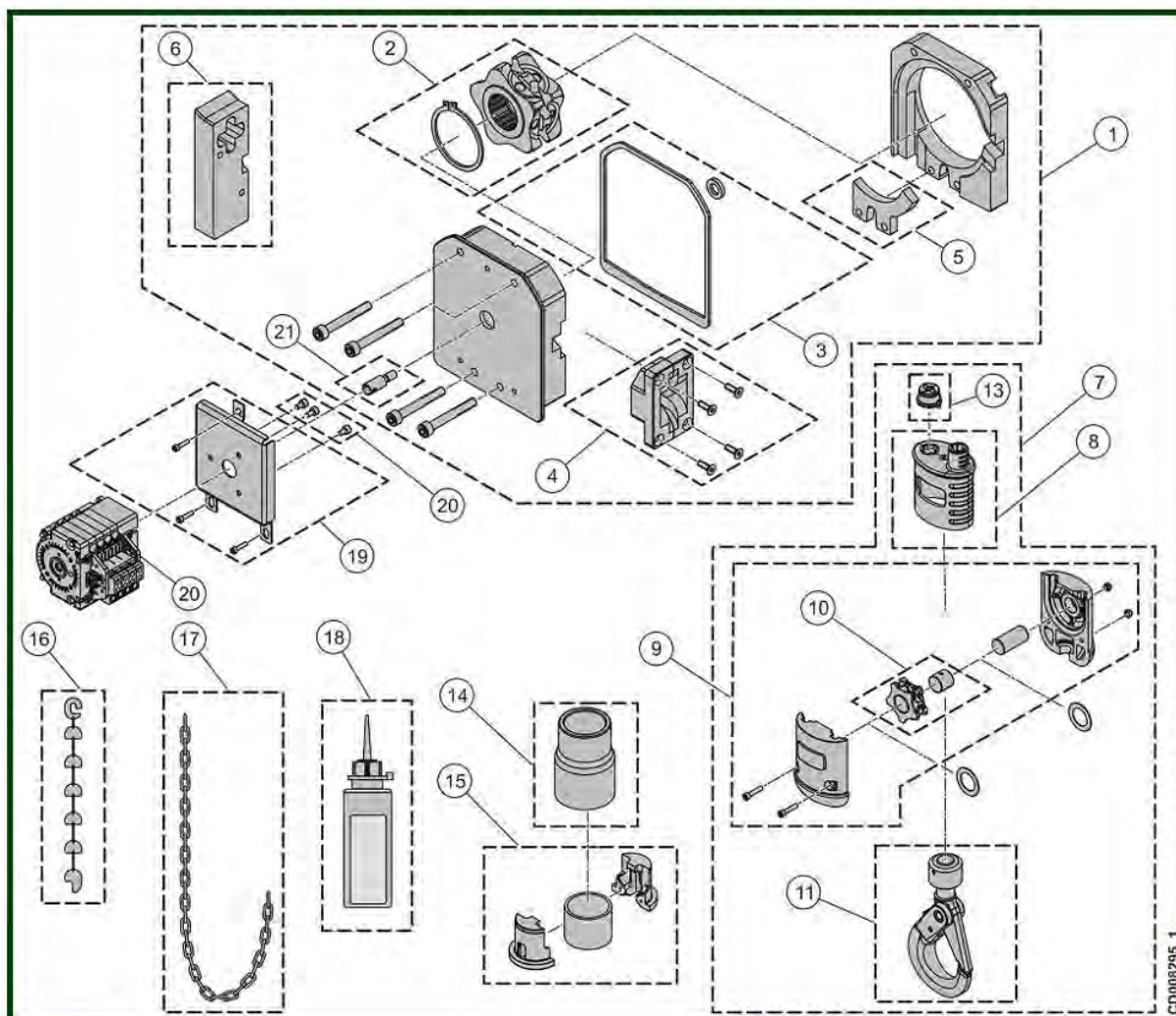

CD008295_1

item	reference	description	observation	Quantity
1	VT0008741	Chain guide	Fin De Course à Cames / Gear Limit Switch	1
2	VT0006587	Chain sprocket set		1
3	VT0008048	Sealings set		1
4	VT0008702	External chain flux		1
5	VT0008732	Plate	L87W67T10	1
6	VT0008737	Chain guide		1
7	VT0008694	Complete hook block	BKT-13-10 Crochet automatique / Automatic hook	1
8	VT0006610	Buffer	L176W118H215	1
9	VT0008697	Hook bottle		1
10	VT0008695	Sprocket set		1
11	VT0007832	Automatic hook assembly	BKT-13-10	1
13	VT0006614	Fixing module	D60L40	1
14	VT0006601	Rubber chain stop		1
15	VT0006602	Chain stop		1
16	VT0006606	Chain fitting tool	Chaîne / Chain 11.3 x 31	1
17	VT0006605	Chain 11.3x31		1
18	VT0006025	Oil cane	CCGCCHCM-01	1
19	VT0008047	Limit switch support		1

20	<u>VT0006113</u>	Geared limit switch - 2 steps with screw set	Hauteur de levée / Lift height : 20 m VR02=>20m : 1brin VR05=>25m : 1brin VR12=>36m : 1 brin - 18m : 2 brins VR16=>48m : 1 brin - 24m : 2 brins VR25=>56m : 1 brin - 28m : 2 brins	1
20	<u>VT0006252</u>	Geared limit switch - 4 steps with screw set	Hauteur de levée / Lift height : 20 m VR02=>20m : 1brin VR05=>25m : 1brin VR12=>36m : 1 brin - 18m : 2 brins VR16=>48m : 1 brin - 24m : 2 brins VR25=>56m : 1 brin - 28m : 2 brins	1
21	<u>VT0008767</u>	Coupling part	D15L41	1

4) Gear

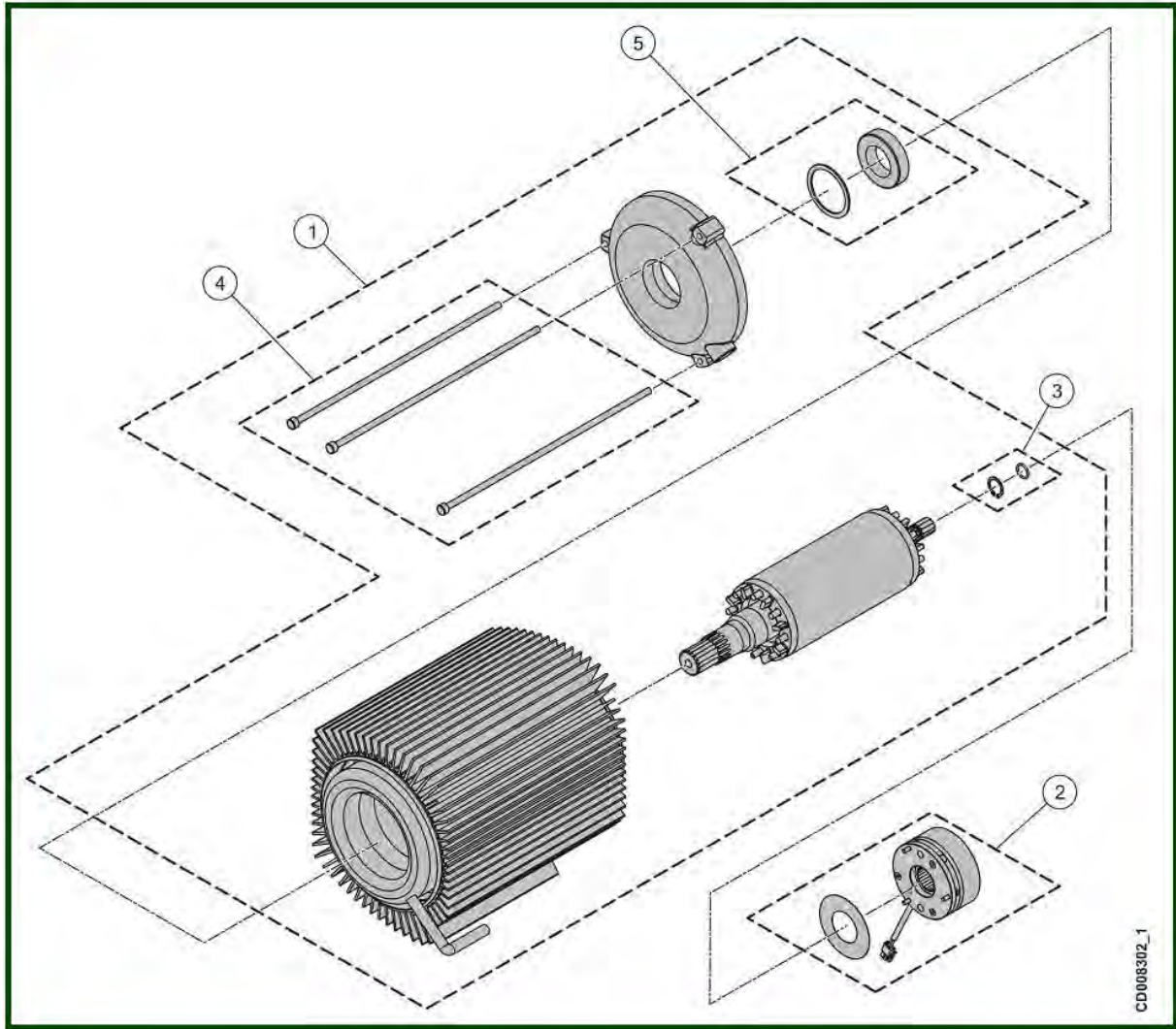

4.1) Single brake

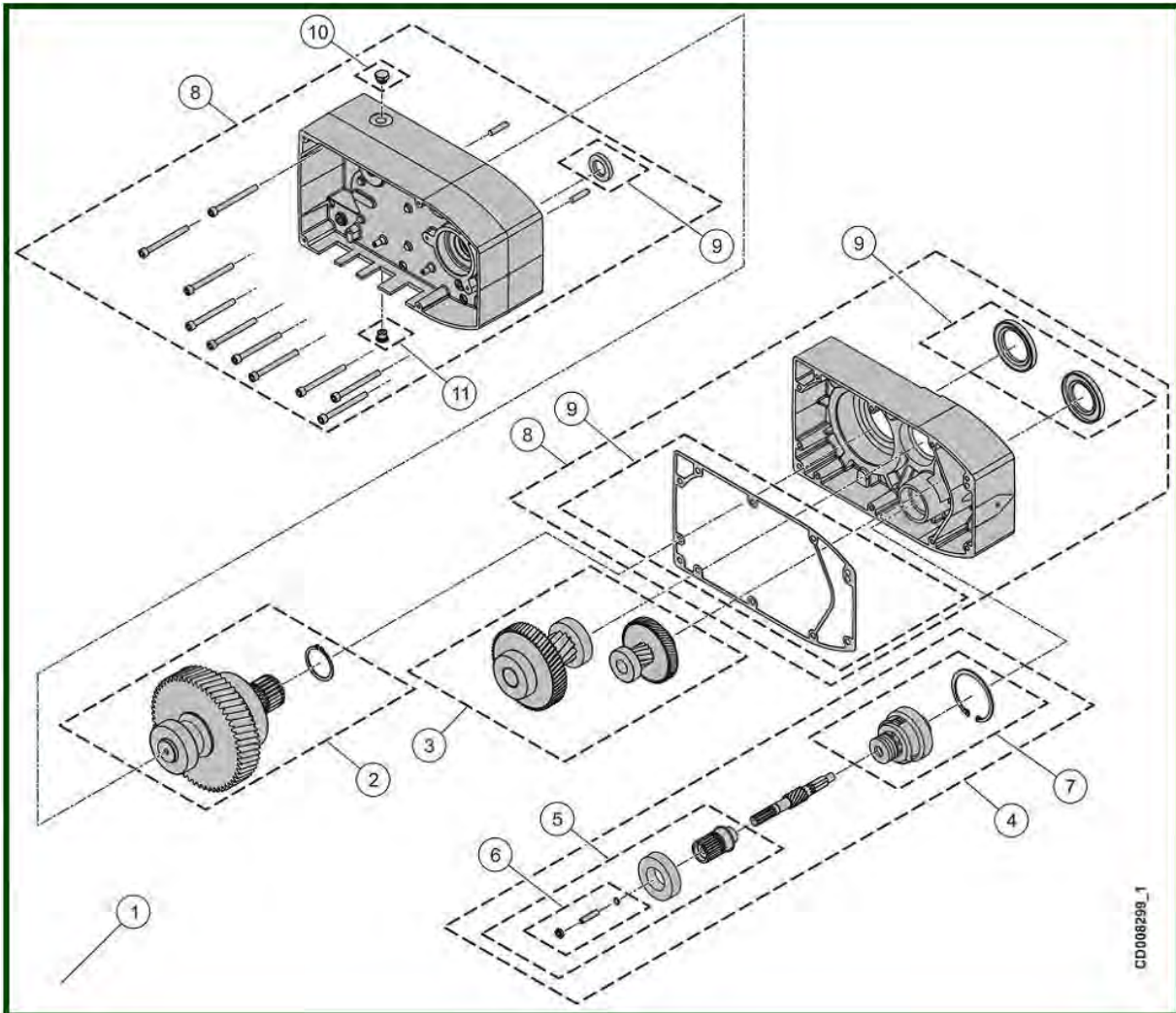

item	reference	description	observation	Quantity
1	VT0006617	Gear assembly - Single brake	4m/min : 2 brins/falls 8m/min : 1 brin/fall	1
2	VT0006625	Primary gear - pinion set		1
3	VT0006626	Second gear pinion set	4m/min : 2 brins/falls 8m/min : 1 brin/fall	1
4	VT0006630	Gear shaft with clutch	Simple frein / Single brake	1
5	VT0006632	Coupling - Brake side	Simple frein / Single brake	1
6	VT0006634	Screw set		1
7	VT0006635	Clutch set		1
8	VT0006636	Frame		1
9	VT0006637	Sealing set		1
10	VT0006638	Breather		1
11	VT0006639	End cap		1

4.2) Double brakes

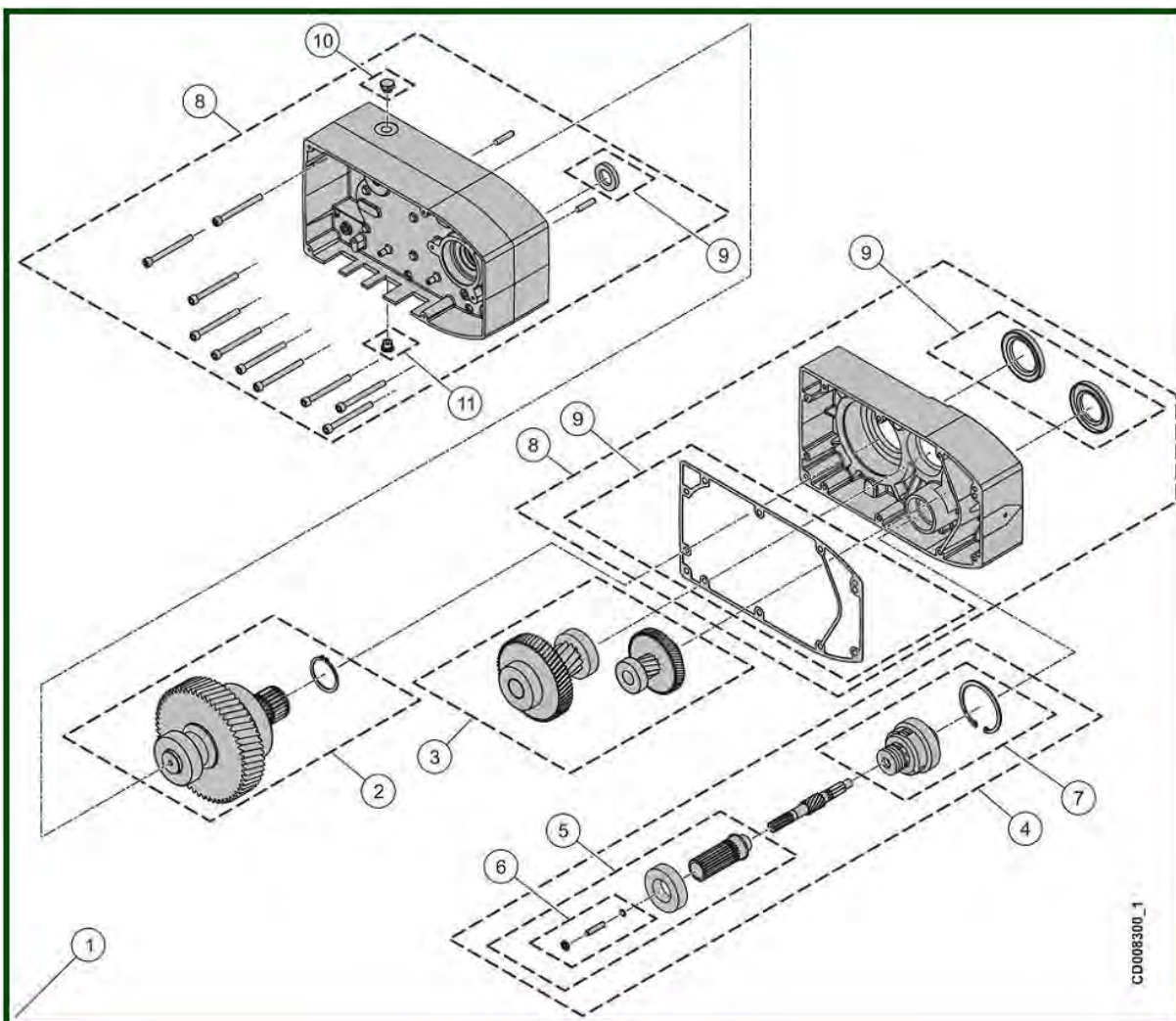

CD008300_1

item	reference	description	observation	Quantity
1	VT0006621	Gear assembly - Double brakes	4m/min : 2 brins/falls 8m/min : 1 brin/fall	1
2	VT0006625	Primary gear - pinion set		1
3	VT0006626	Second gear pinion set	4m/min : 2 brins/falls 8m/min : 1 brin/fall	1
4	VT0006631	Gear shaft with clutch	Doubles freins / Double brakes	1
5	VT0006633	Coupling - Brake side	Doubles freins / Double brakes	1
6	VT0006634	Screw set		1
7	VT0006635	Clutch set		1
8	VT0006636	Frame		1
9	VT0006637	Sealing set		1
10	VT0006638	Breather		1
11	VT0006639	End cap		1

5) Motor

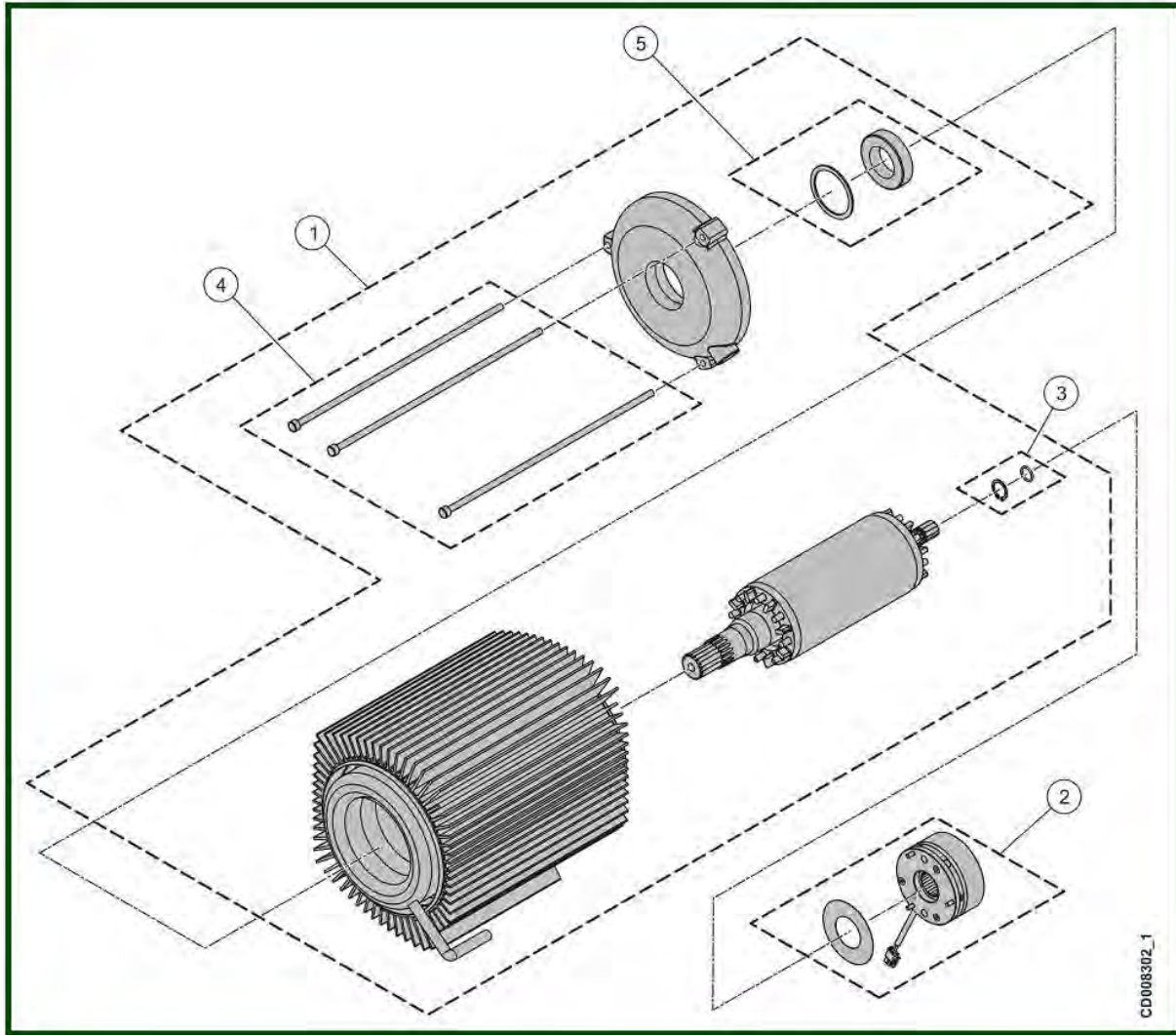

item	reference	description	observation	Quantity
1	VT0008671	Complete motor	400V / 50Hz	1
2	VT0007886	Single brake	103VDC - 230V Double freins = Simple frein x 2 Double brakes = Single brake x 2	1
2	VT0007885	Single brake	180VDC - 400V Double freins = Simple frein x 2 Double brakes = Single brake x 2	1
2	VT0007887	Single brake	255VDC - 500V Double freins = Simple frein x 2 Double brakes = Single brake x 2	1
2	VT0007888	Single brake	320VDC - 600V/690V Double freins = Simple frein x 2 Double brakes = Single brake x 2	1
3	VT0006654	Retaining set		1
4	VT0006655	Screws set		1
5	VT0005912	Bearing set		1

6) Electrical parts

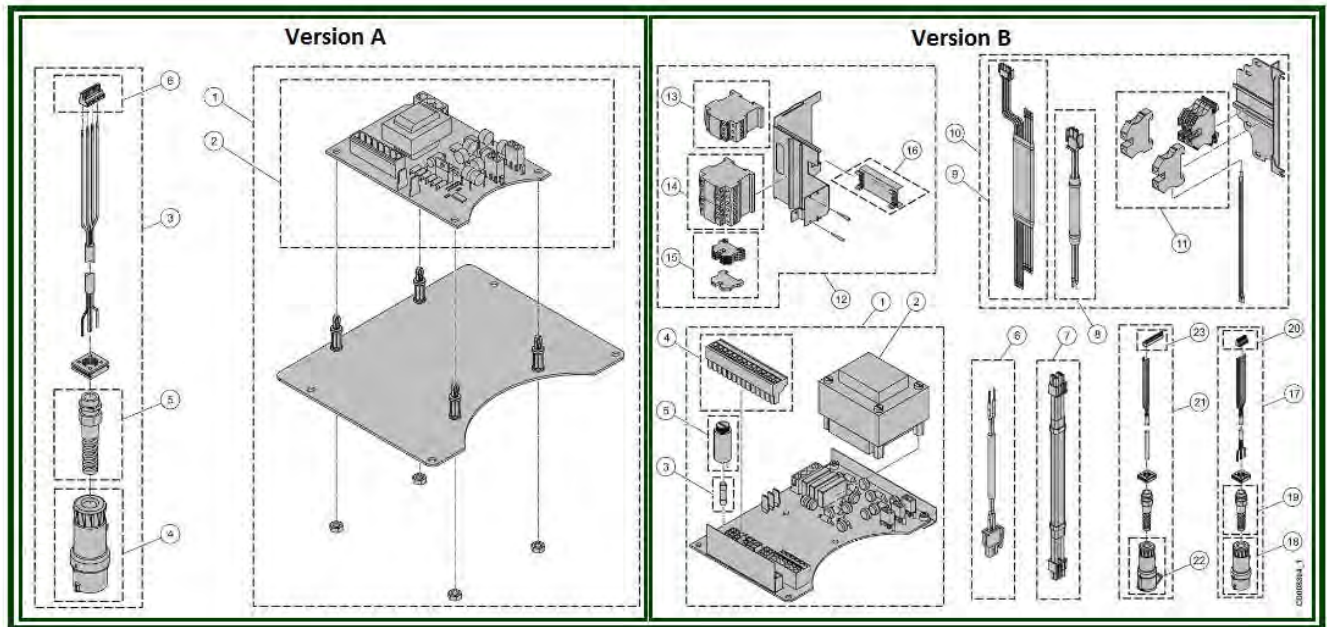

6.1) Version A

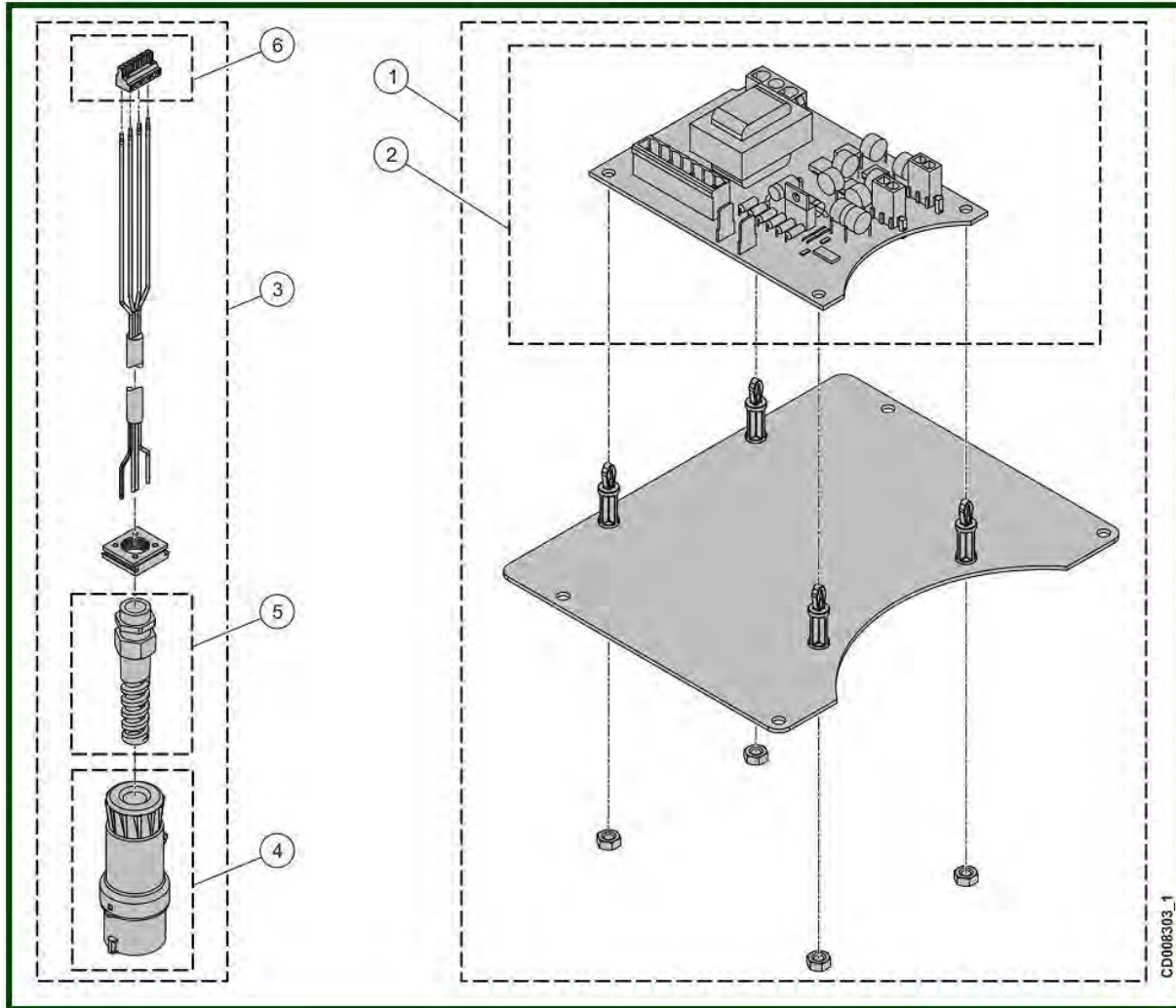

item	reference	description	observation	Quantity
1	VT0008773	CI Board	230-600V / 50-60Hz	1
2	VT0006000	ACF card	208-600V - 1 vitesse / 1 speed	1
3	VT0006078	Power supply male blue plug with cable	230V / 50-60Hz / 3P+T 0,5m	1
3	VT0006076	Power supply male red plug with cable	380-415V / 50-60Hz - 400V- 3P+T 0,5m	1
4	VT0006087	Power supply male blue plug	230V / 3P+T	1
4	VT0006086	Power supply male red plug	400V / 3P+T	1
5	VT0006399	Spiral cable gland		1
6	VT0005107	Connector	4P	1

6.2) Version B

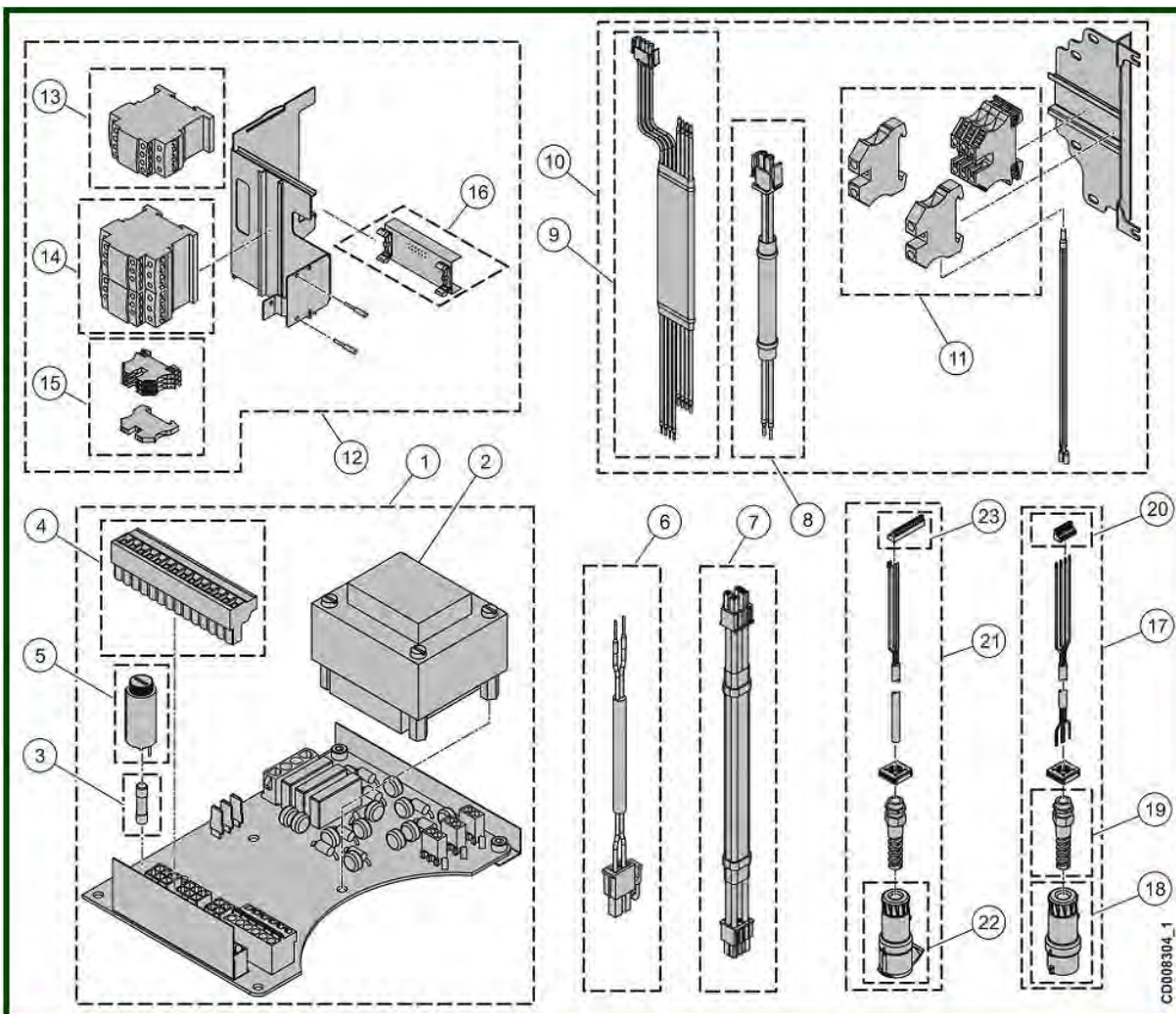

CD008304_1

item	reference	description	observation	Quantity
1	VT0007668	CI board	208-230V/110-115V/50-60Hz	1
1	VT0007667	CI board	230V / 48V / 50-60Hz	1
1	VT0006657	CI board	380-415V / 48V / 50-60Hz	1
1	VT0007665	CI board	380-415V / 110-115V / 50-60Hz	1
1	VT0007666	CI board	380-415V / 230V / 50-60Hz	1
1	VT0007669	CI board	440-480V / 48V /50-60Hz	1
1	VT0007670	CI board	440-480V / 110-115V / 50-60Hz	1
1	VT0007671	CI board	500-525V / 48V / 50-60Hz	1
1	VT0007672	CI board	500-525V/110-115V / 50-60Hz	1
1	VT0007695	CI board	500-525V/230V / 50-60Hz	1
1	VT0007673	CI board	575V/48V / 50-60Hz	1
1	VT0007674	CI board	575V/110-115V / 50-60Hz	1
1	VT0007675	CI board	690V /48V / 50-60Hz	1
1	VT0007676	CI board	690V /110-115V / 50-60Hz	1
2	VT0007684	Transformer	230V/48V / 50-60Hz	1
2	VT0007685	Transformer	230V/110-115V / 50-60Hz	1
2	VT0006658	Transformer	380-415V / 48V / 50-60Hz	1
2	VT0007682	Transformer	380-415V / 110-115V / 50-60Hz	1
2	VT0007683	Transformer	380-415V / 230V / 50-60Hz	1
2	VT0007686	Transformer	440-480V/48V / 50-60Hz	1

2	VT0007687	Transformer	440-480V/110V-115V / 50-60Hz	1
2	VT0007688	Transformer	500-525V/48V / 50-60Hz	1
2	VT0007689	Transformer	500-525V/110V-115V / 50-60Hz	1
2	VT0007690	Transformer	500-525V/230V / 50-60Hz	1
2	VT0007691	Transformer	575V / 48V / 50-60Hz	1
2	VT0007692	Transformer	575V / 115V / 50-60Hz	1
2	VT0007693	Transformer	690V / 48V / 50-60Hz	1
2	VT0007694	Transformer	690V / 110-115V/ 50-60Hz	1
3	VT0007706	Fuses set	Commande / Control voltage 24V/48V	1
3	VT0007707	Fuses set	Commande / Control voltage 110V/115V	1
3	VT0007306	Fuses set	Commande / Control voltage 230V	1
5	VT0006191	Fuse base		1
6	VT0008550	GLS cable	Quantité : 2 pour 2 Cames ou 4 pour 4 Cames Quantity : 2 for 2 steps or 4 for 4 steps	1
7	VT0006662	Linking cable	230V / 24V / 50-60Hz - Faisceau	1
8	VT0008698	Wire Harness	230V / 24 / 50-60Hz - Contrôle	1
9	VT0008699	Wire Harness	208-690V / 50-60Hz - Puissance	1
10	VT0008700	Power supply board	208-690V / 50-60Hz	1
11	VT0008735	Terminal block set		1
12	VT0007680	Electrical board - 2HS	208-230V / 48V / 50-60Hz	1
12	VT0007681	Electrical board - 2HS	208-230V / 110-115V / 50-60Hz	1
12	VT0006666	Electrical board - 2HS	380-690V / 48V / 50-60Hz	1
12	VT0007678	Electrical board - 2HS	380-690V / 110-115V / 50-60Hz	1
12	VT0007679	Electrical board - 2HS	380-690V / 230V / 50-60Hz	1
13	VT0007699	Selector contactor	208-230V / 48V / 50-60Hz	1
13	VT0007700	Selector contactor	208-230V / 110V / 50-60Hz	1
13	VT0006737	Selector contactor	380-690V / 48V / 50-60Hz	1
13	VT0006740	Selector contactor	380-690V / 110-115V / 50-60Hz	1
13	VT0006741	Selector contactor	380-690V / 230V / 50-60Hz	1
14	VT0007701	Selector contactor	208-230V / 48V / 50-60Hz	1
14	VT0007702	Selector contactor	208-230V / 110V / 50-60Hz	1
14	VT0006743	Selector contactor	380-690V / 48V / 50-60Hz	1
14	VT0007704	Selector contactor	380-690V / 110V-115V / 50-60Hz	1
14	VT0007705	Selector contactor	380-690V / 230V / 50-60Hz	1
15	VT0007709	Terminal block set		1
16	VT0006732	Terminal block set	230V / 24 - 50/60Hz	1
17	VT0006078	Power supply male blue plug with cable	230V / 50-60Hz / 3P+T 0,5m	1
17	VT0006076	Power supply male red plug with cable	380-415V / 50-60Hz - 400V- 3P+T 0,5m	1
18	VT0006087	Power supply male blue plug	230V / 3P+T	1
18	VT0006086	Power supply male red plug	400V / 3P+T	1
19	VT0006399	Spiral cable gland		1
20	VT0005107	Connector	4P	1
21	VT0008701	Connection plug - Female	24-48V / 115V / 50-60Hz - 0,5 m	1
22	VT0006761	Control yellow plug - Female	115V - 3P+T	1
23	VT0005108	Connector	14P	1